

THE BREECH-LOADER

AND HOW TO USE IT



W. W. GREENER

This is a reproduction of a book from the McGill University Library collection.

Title: The breech-loader and how to use it
Author: Greener, W. W. (William Wellington)
Publisher, year: London : Cassell & co. Ltd., 1892

The pages were digitized as they were. The original book may have contained pages with poor print. Marks, notations, and other marginalia present in the original volume may also appear. For wider or heavier books, a slight curvature to the text on the inside of pages may be noticeable.

ISBN of reproduction: 978-1-926671-90-1

This reproduction is intended for personal use only, and may not be reproduced, re-published, or re-distributed commercially. For further information on permission regarding the use of this reproduction contact McGill University Library.

McGill University Library
www.mcgill.ca/library

THE BREECHLOADER,
AND HOW TO USE IT.

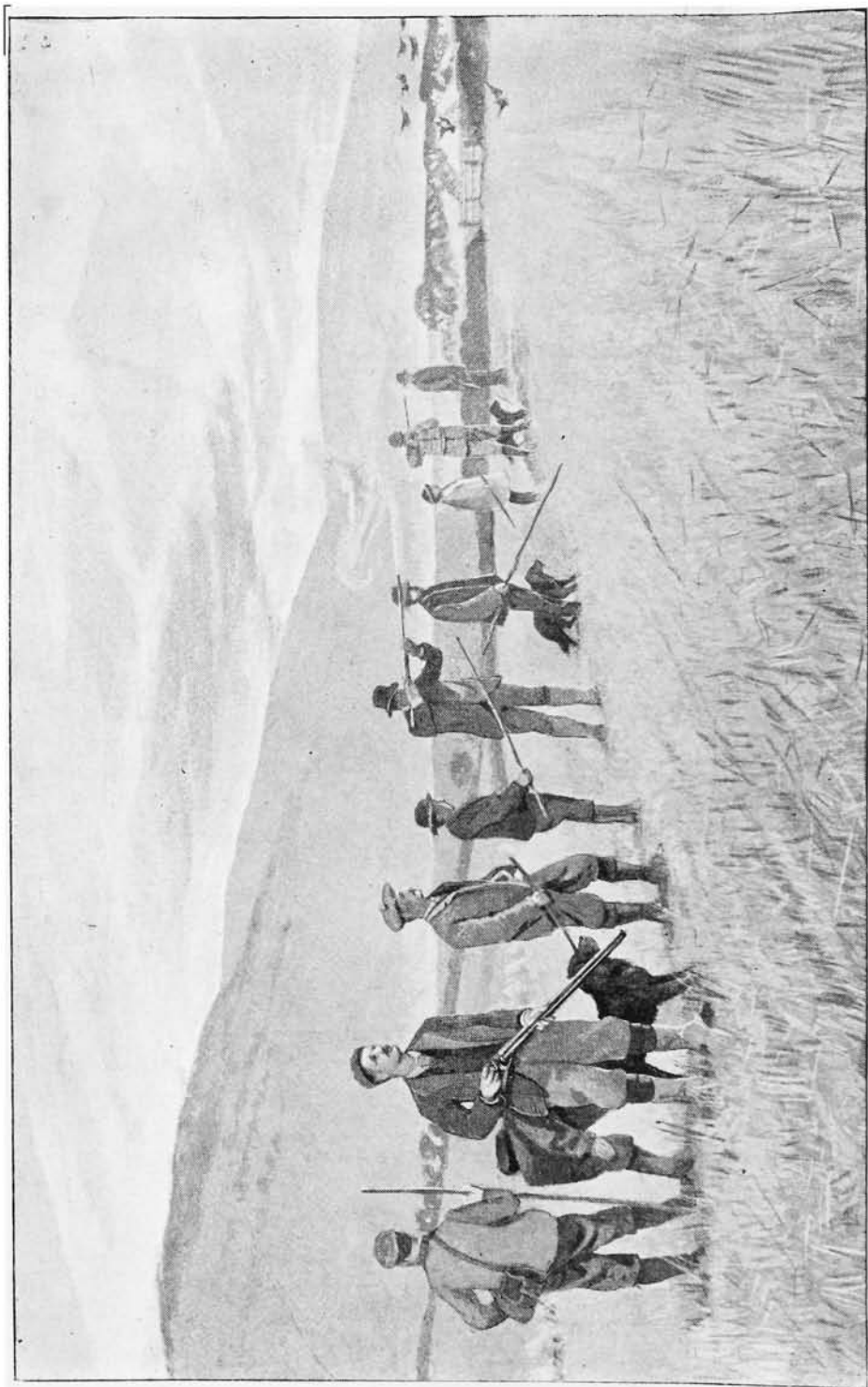

THE FIRST COVEY.

THE BREECH-LOADER,

AND HOW TO USE IT.

BY

W. W. GREENER,

*Author of "The Gun and its Development," "Modern Shot Guns,"
"Choke-Bore Guns," "Modern Breech-Loaders," etc.*

Illustrated.

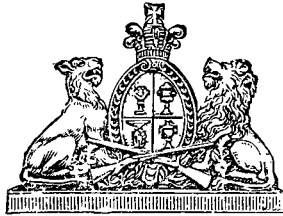

CASSELL & COMPANY, LIMITED:

LONDON, PARIS & MELBOURNE.

1892.

[ALL RIGHTS RESERVED.]

INTRODUCTION.



THIS treatise is written for that numerous class of sportsmen who delight in a day's shooting, but have neither the time nor the means to make the sport a life's study. Published at a popular price, it will, it is hoped, reach many who have hitherto been deterred from shooting, believing it to be an expensive recreation. The author's aim is to induce all who can to participate in a manly sport, and to advance the interests of those who can look to the Gun for pleasure, health, or occupation.

The book is not written for experts, nor for those who have special opportunities for the acquisition of the art of shooting ; and in order to make it as attractive as possible to the general reader, many matters which would interest the enthusiastic shot only, have been omitted.

ERRATA.

Page 130, line 16, for "36 inches" read "30 inches."

Page 142, inscription under diagram should read :
"Fac-simile of shooting of an Improved Cylinder at
forty yards, with 3 drs. Black powder, $1\frac{1}{8}$ oz. No. 6 shot
reduced by photography)."

Page 148, line 8, read "Convenient *for* good shots."

CONTENTS.



CHAPTER I.

	PAGE
The Shot-Gun : its Invention, History, and Varieties—The component Parts of a Gun—The Material for Gun-Barrels—Calibres, Weights, and Standard Charges ...	I

CHAPTER II.

On the choice and fit of a Gun—Spurious, Sham, and Second-hand Guns—The Quality, Price, and Manufacture of Guns—The Gun that will suit—Ordering by Letter—Choosing from Stock	47
--	----

CHAPTER III.

Of the Shape and Dimensions of Gun-Stocks—Shooting Unamended by fit of Gun—Of the fit of Guns—How to choose a Gun that will fit Correctly—Oliver's Sight-Aligner and adjustable Gun—Position in Shooting ...	73
--	----

CHAPTER IV.

Handling the Gun—How to put Guns together—How to clean and keep in Good Order—How to prevent Break-ages and Damage—How and when to send for Repairs—Temporary Breakdowns and the Remedy—Rough-and-ready Repairs	103
--	-----

CHAPTER V.

The Essentials of a Gun—The Flight of a Charge of Shot—Pattern, Penetration, Velocity, Stringing, Spread, Range, Recoil—Large-Bore Guns—The Pigeon Gun—The Game Gun—Choke-Bores <i>versus</i> Cylinders—How to Load—Useful Loads... ..	124
--	-----

THE BREECH-LOADER,

AND HOW TO USE IT.



CHAPTER I.

THE SHOT-GUN: ITS INVENTION, HISTORY, AND VARIETIES — THE COMPONENT PARTS OF A GUN—CALIBRES, WEIGHTS, AND STANDARD CHARGES.

THE first use of small shot in fire-arms was made by German peasants and shepherds about the middle of the sixteenth century, and from the single barrel-wheel lock musket of those days the present almost perfect type of sporting weapon has been slowly evolved. It was not until the middle of the seventeenth century that double guns were made small and light enough to be of use for sporting purposes, and it was a century later before ribs were added.

The flint-lock gun, as made at the commencement of the present century, was regarded by the sportsmen of those days as an almost perfect weapon. That celebrated maker, Joseph Manton,

lived long enough to see the introduction of percussion-caps, and joined in the stormy discussions as to the merits of detonating balls, caps, and flints—questions which vexed the sportsmen of his day.

The percussion-cap gun was a great improvement on the flint-lock, and although its day was short, it may be regarded as the most durable gun ever made, or probably ever to be made. Gun-makers then reverted to an ancient principle: that of breech-loading, and the much over-rated Lefauchaux gun and the truly great achievement of making the cartridge-case contain its own means of ignition were the immediate results.

The principle of dropping down the barrels for loading is that most generally adhered to by gun-makers, and has now attained its most perfect form. The pin-fire, or Lefauchaux cartridge, was quickly superseded by the central-fire system, introduced into this country by Mr. Daw, of Threadneedle Street, about 1861, and so enthusiastically championed by him as to become almost immediately popular. The great advantages of the central-fire system are—increased safety from accidental discharge, and greater certainty of ignition, non-escape of gas round the pin-hole, greater cleanliness, and greater speed in loading.

The rebounding lock by which the hammer rebounds automatically until it stands free from the striker is the latest important improvement applicable to the central-fire gun of all systems of

breech-loading, but has in turn been quite superseded by the hammerless gun.

Before considering the advantages of the various types of modern guns, it may be advisable to give in detail the component parts of a gun, with such particulars concerning them as will enable any one quite unacquainted with fire-arms nomenclature to understand such technical terms as are found in all treatises of this kind, and know a gun thoroughly.

BARREL.

The tube in which the charge is fired, usually of iron rods welded together, sometimes of steel, drilled or rolled. In double guns the tubes are brazed together at the breech end, the lumps for holding the tubes to the breech-action body being dovetailed into them and brazed. The ribs are the bands of metal soldered to the tubes from breech to muzzle, the loop the small lump to which the fore part of the breech mechanism is attached.

The iron for the manufacture of gun-barrels was formerly made from scrap and old horse-shoe nail stubs. The modern way of preparing the metal for gun-barrels is to make the whole from new metal, as follows:—Bars of prepared steel and superior gun-iron are placed together in fagots alternately, then heated to welding heat in a furnace, and placed under a tilt hammer, and welded into one bar, which is passed through rolls and cut into pieces; then go through the same

processes of hammering and welding again. The best metals made by this process are laminated steel and fine Damascus, the former containing a larger proportion of steel.

The cheapest kind of twist barrels is that called scelp twist, as illustrated. It is made from the commonest gun-iron, drawn out into ribands, and coiled round a mandril, and afterwards welded together. When finished and browned, the figure consists of narrow lines, light and dark alternately, which run spirally round and round the barrels, from breech to muzzle. This kind of barrel is used on the commonest guns only.

DAMASCUS.

The Damascus and laminated barrels differ only in the way that the iron and steel are put together in the first process.

For the cheaper or single-iron Damascus, a square rod is taken about four feet long and five-eighths inch thick, and placed in a forge fire until about eighteen inches of the rod is brought to a red heat, when one end is thrust into a square hole in a block made fast to a frame, and the other end fixed into a movable head at the other end of the frame. A rotating motion is then given to the movable head by means of a winch-handle and cog-wheels. The rod, being square, cannot turn round with the head, so is twisted on itself.

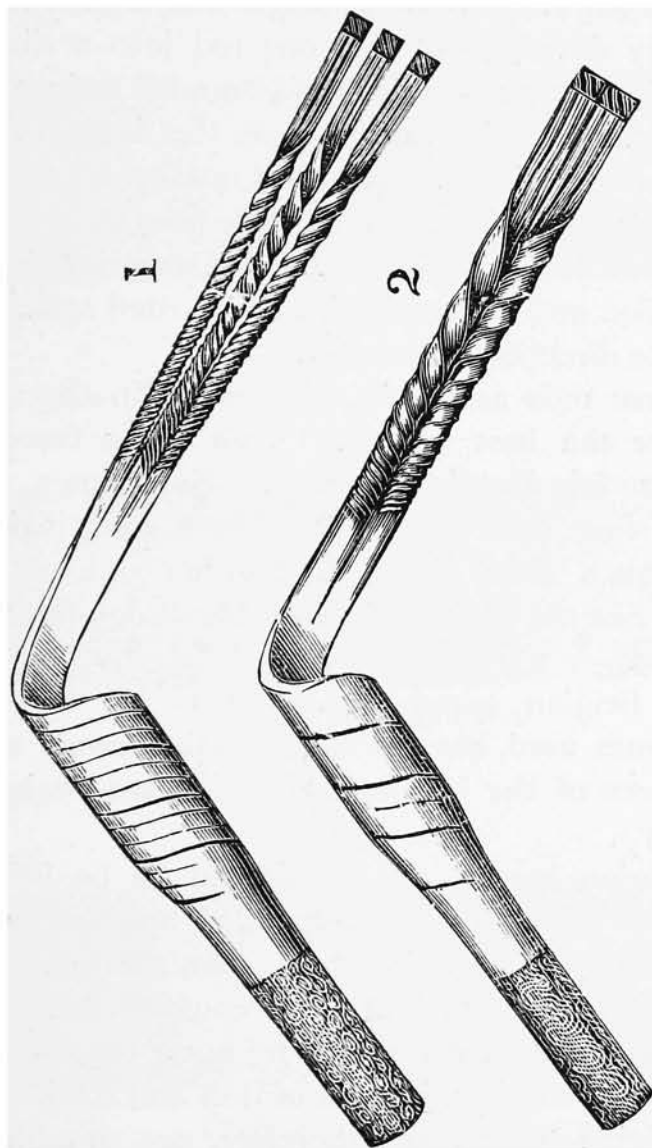

Processes of Barrel Welding.
(1) Three-Iron Damascus; (2) Two-Iron Damascus.

The cheaper quality laminated steel, which is also known in the trade as single-iron Damascus, is made by drawing out this one rod into a riband, which is afterwards coiled on a mandril and welded together. The illustration shows the figure of the barrel when finished. The next quality is two-iron Damascus or laminated steel, made from two twisted rods, each three-eighths square, and welded together and rolled into a riband, with the twisted spirals in opposite directions, as shown.

Three rods are used, and welded in the same way for the best barrels. This is the favourite number for English barrels. Sometimes, but rarely, four rods are used. Three rods make a very much finer figure than either one or two rods. See the barrels of the treble-wedge-fast gun, page 29.

In Belgian barrels as many as six rods are sometimes used, but the over-twisting rends apart the fibres of the iron and the rods are weakened thereby.

Belgian barrels are considered to be inferior to those made in Birmingham, on account of the soft material used in their manufacture, there being but little steel in their composition. The figure is frequently obtained by using two different preparations of iron instead of iron and steel.

Belgian barrels are, therefore, not suitable for full choking.

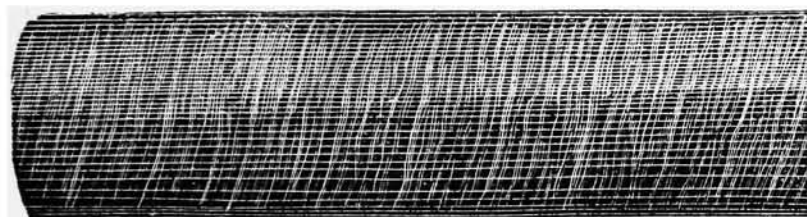

Scelp Gun-Barrel.

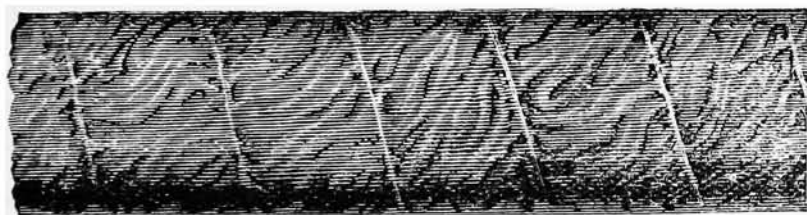

Single-Iron Damascus Barrel.

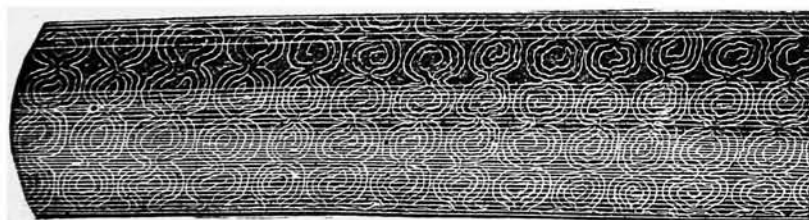

Two-Iron Damascus Barrel.

STERLING STEEL AND HOMOGENEOUS METAL
FOR GUN-BARRELS.

Apart from the question as to which metal is the best for shot-gun barrels, it is possible to consider the merits of steel and iron alloys as material suitable for manufacture into gun-barrels.

Steel of good quality has been proved to possess sufficient strength to resist the strain to which a shot-gun barrel is ordinarily subjected; and Messrs. Whitworth, by careful manufacture, have turned out barrels of a uniform quality of excellence.

The question of steel as a suitable metal for gun-barrels has occupied the attention of gun-makers for several years, and, after many experiments, a superior description of steel possessing valuable qualities has been adopted. "Sterling Steel" is the name given by the author.

The mode of manufacture is not to draw the steel at all, as generally understood, but to forge out the barrel into a solid rod, and afterwards drill the whole length. Barrels so made are of closer metal, stronger and denser than any obtainable by other means.

The "Sterling Steel" recommended is made of a homogeneous metal, of very fine quality, and admirably adapted by its great tenacity, or tensile strength, for use in gun-barrels. It has been thoroughly tested by the author, as well as at the

Government Proof House, with heavy charges—viz., 28 drams of powder and $4\frac{1}{2}$ ounces of shot, this charge being equal to seven ordinary charges of powder and four charges of shot. This test and many others it withstands perfectly.

“Sterling Steel” barrels are of sufficient strength for all practical purposes, and only in appearance are they at a disadvantage when compared with twisted Damascus and laminated steel barrels.

Unlike “Cast Steel” barrels of the old type, “Sterling Steel” barrels bulge instead of breaking, and increased strain produces an open burst similar to that of a welded barrel, instead of a sharp break or longitudinal rip, as is found to result with imperfect steel barrels. The quality of the metal is such that it will stand successively more than double the strain to which a sportsman can submit his gun with fair usage. And it will not “rip” or “crack,” however sharp may be the explosive used.

Good steel barrels have the following advantages over the Damascus barrels: they are less liable to honeycomb from the corrosive action of gunpowder; they are not so easily bent from rough usage as twisted barrels, and, being harder, they are not so likely to be injured when accidentally dropped. Many guns have been ruined by this cause alone.

There are no welds in these barrels; they are absolutely free from greys or flaws of any descrip-

tion. They may be relied upon as being equal to those manufactured by the Whitworth Company; and, further, they do not add to the cost of the gun, whereas Whitworth barrels cost more, and "Sterling Steel" is always obtainable without the annoying delays which often result when a special barrel is required of Whitworth metal.

The bulges shown in the illustration were caused by placing a small charge of shot between two felt wads (first a thick felt, then the shot, then the thin felt) at the spot where the bulges are, and firing an ordinary charge from the gun.

The burst was effected by increasing the charge of shot between the wads, the bulges appearing about fifteen inches from the breech end after firing.

As many as five thick wads may be placed in any part of the barrel, and the gun fired without causing a bulge, but, as proved by experiment, even the small quantity of $\frac{1}{8}$ -ounce shot, placed between wads, at any place in the barrel, will cause a bulge even as near as nine inches from the breech. The different sizes of the bulges in the illustration were caused by different charges of shot. The shape of the burst indicates the extent of bulging before bursting. The illustration is reduced to half size.

As to the shooting qualities of steel barrels, it is not claimed that they shoot better than those of ordinary gun iron, as good shooting is only obtained by skill in boring; but steel, being harder,

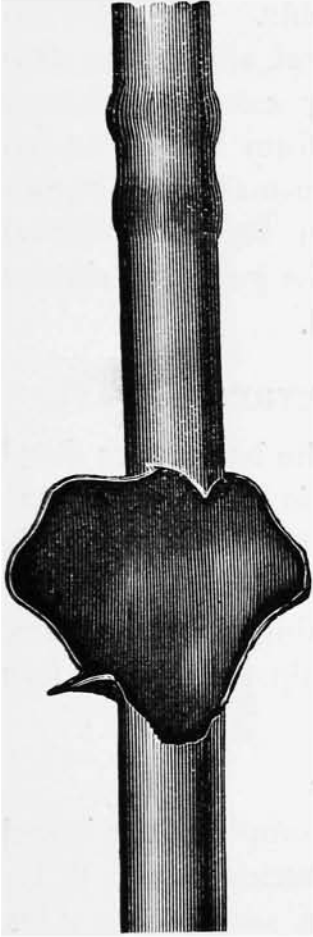

Bulges and burst in a Barrel of "Sterling Steel." (Reduced to half size.)

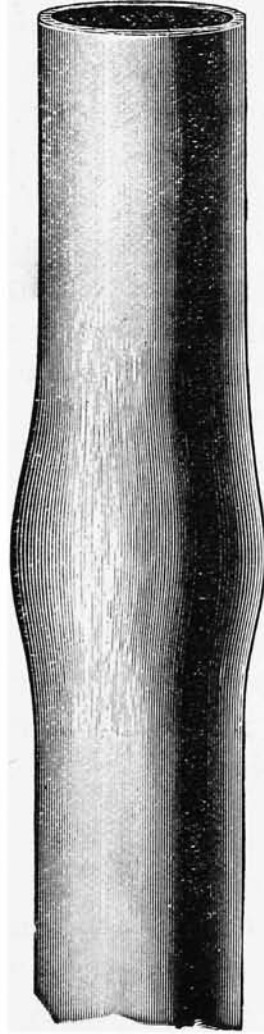

Bulge in "Sterling Steel" Barrel, caused by an Obstruction in the Muzzle during Proof. (Full size.)

they should retain their shooting qualities longer than those of softer metal.

Other steels may possess the tenacity required of the material for shot-gun barrels, but none have yet proved so reliable. The alloys of iron, manganese steel, nickel steel, aluminium steel, and other materials possessing essential features, are not yet made of such uniform quality as will admit of their adoption by gun-makers of reputation for making into shot-gun barrels, although undoubtedly of such an alloy the guns and rifles of the future will be manufactured.

THE BREECH-ACTION

consists of the body to which the barrels are fitted, and in which the lock-work is arranged or attached, the bolts to secure the barrels to the body, the lever-spring, &c., to work the bolts, the joint-pin on which the barrels are hinged by the barrel lump, and the knuckle-joint against which the fore-part abuts.

FORE-PART.

A detachable piece which completes the breech mechanism, and forms the knuckle-joint; it lies under the barrel, to which it is secured by a fastener engaging with the barrel loop. (*See Illustrations.*)

LOCK-WORK.

The firing mechanism of the weapon consists

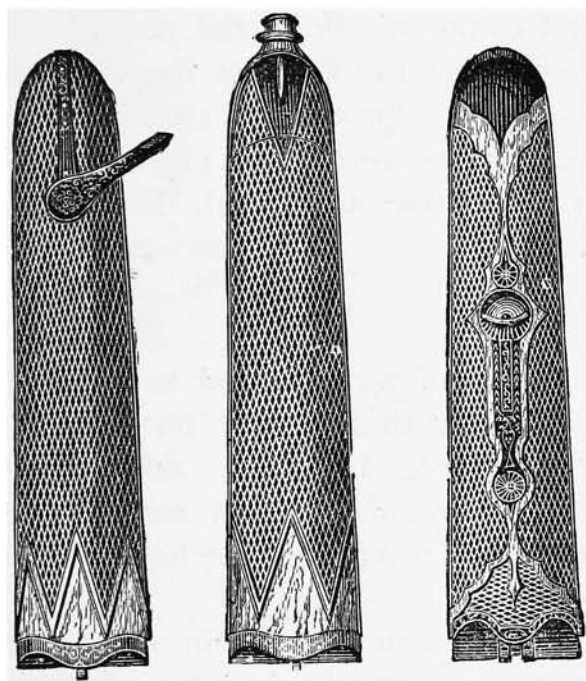

1

2

3

FORE-ENDS.

Grip.

Anson.

Deeley and Edge.

mainly of a spring, which is compressed as the hammer is cocked, a sear which enters a notch in the tumbler to hold the hammer at cock until the trigger is pulled, and such firing pins, nipples, pins, bridles, &c., as are necessary to secure the mechanism to the lock-plate in the breech-action body, and communicate to the percussion-cap, in the cartridge-case, the force of the blow given by the liberated mainspring. It also includes safety bolts and various devices to protect the user of the gun from the accidental discharge of the weapon.

STOCK.

The handle of walnut-wood to which the gun is fixed, in order that it may be fired from the shoulder, aligned, balanced, and the various mechanisms manipulated with ease. The furniture of the stock consists of the heel-plate, trigger-guard, &c.

The modern gun is made in various styles, of divers types, and several principles of breech-loading. The characteristics of these are illustrated by the following descriptions :—

The original Lefauchaux gun, with lever moving horizontally to the right, and lying under and parallel to the barrels when the gun is closed, is rarely seen in this country. On the continent and in the French, Portuguese, and Dutch colonies it is still found in daily use.

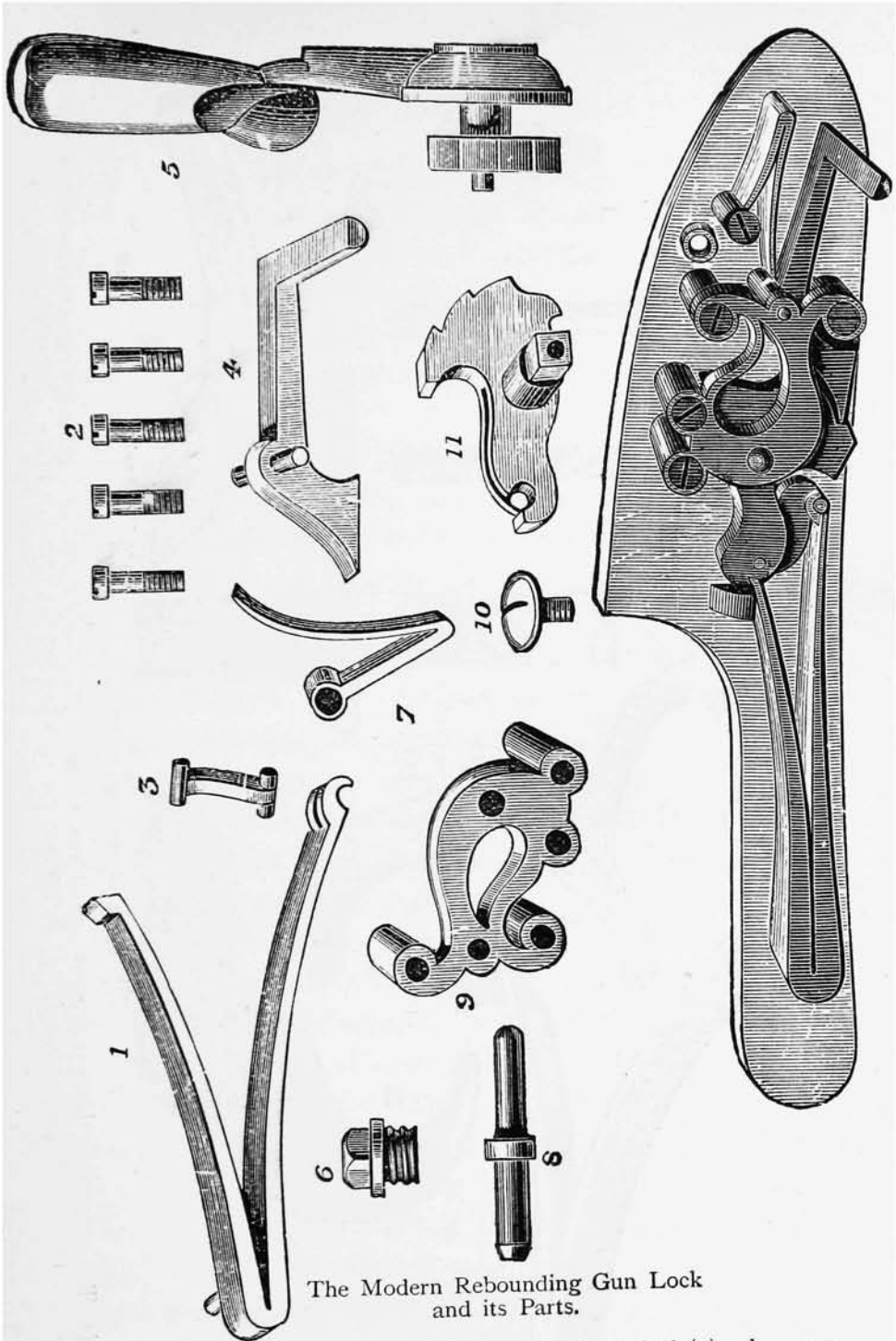

(1) The bridle and scar-spring pins (2); the swivel (3); the scar (4); the scar-spring (7); the bridge (9); the tumbler (11); the tumbler-pin (10); the firing mechanism in connection with the lock consists in its simplest form of the hammer (5); the striker (8); the nipple (6).

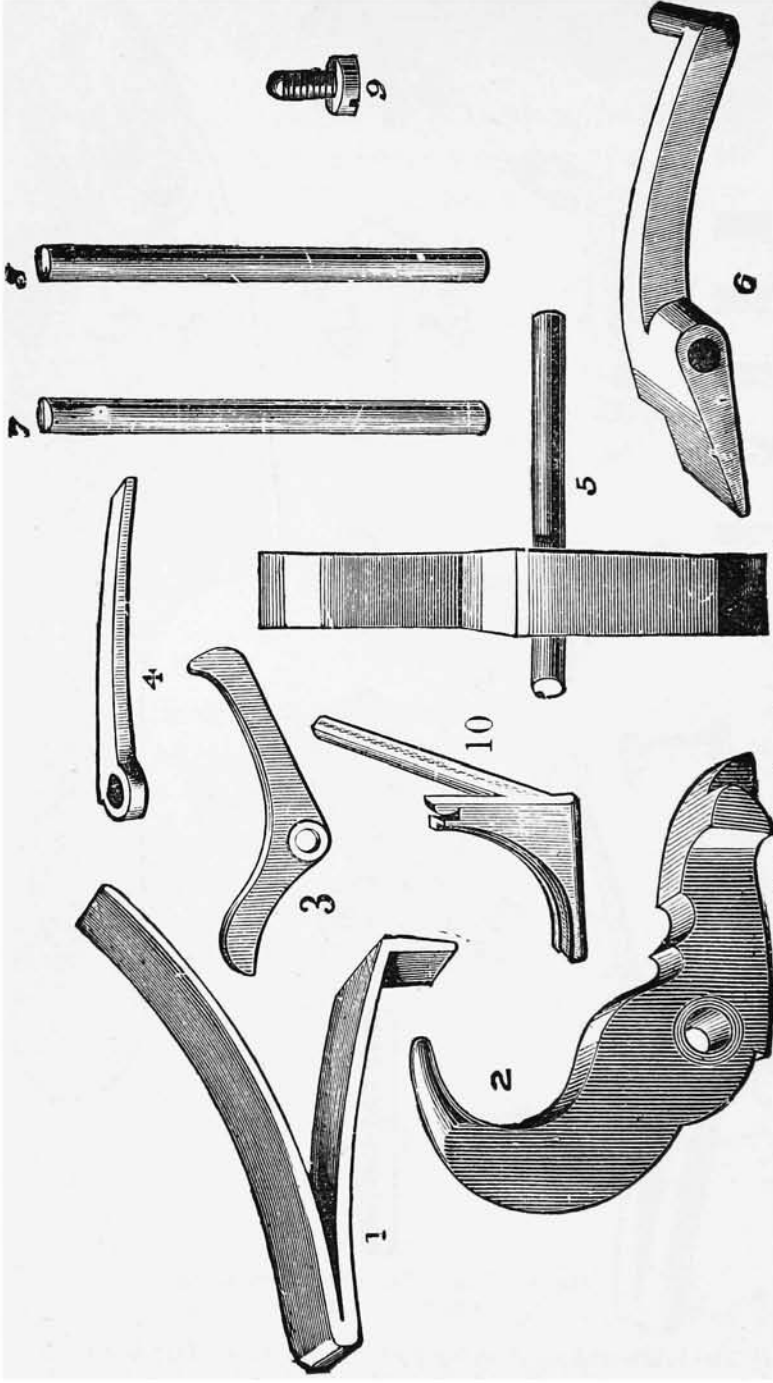

The Lock Mechanism of an Ejector Hammerless Gun.

(1) The mainspring ; (2) the tumbler and striker in one ; (3) an ejecting lever ; (4) sear-spring ; (5) a tumbler pivoted on a pin ; (6) the sear ; (7 and 8) tumbler and sear pivots ; (9) sear-springless pin ; (10) extractor.

The English modification of this principle of breech mechanism is known as the double-grip gun, and is applicable to the central-fire system; and although now practically obsolete, was some years ago very popular with all classes of sportsmen, and will be found in every gun-maker's stock.

The side-lever snap-action gun has one staunch adherent in the English gun trade; it was at one time much patronised by American sportsmen, but the consensus of opinion is now in favour of the top-lever form of breech-action in one of its several varieties. With the lever on the top of the breech, it is possible to carry the gun in any safe manner without catching or displacing the lever. The sportsman cannot be mistaken as to the gun being properly fastened, whilst its position and short horizontal travel to the right make it the handiest, as well as the easiest, to manipulate.

There are many forms of breech mechanism actuated by the top-lever. The most common is that known as the double-bolt. This bolt travels in a longitudinal slot in the breech-action body, and engages with the lump on the barrel by entering two notches cut one into each division of the under lump. Occasionally it is made to engage with one only, that nearest the breech, which is a single bolt; and in some special guns the lump projects rearward from beneath the barrels, in order to form a better and stronger bearing for the holding-

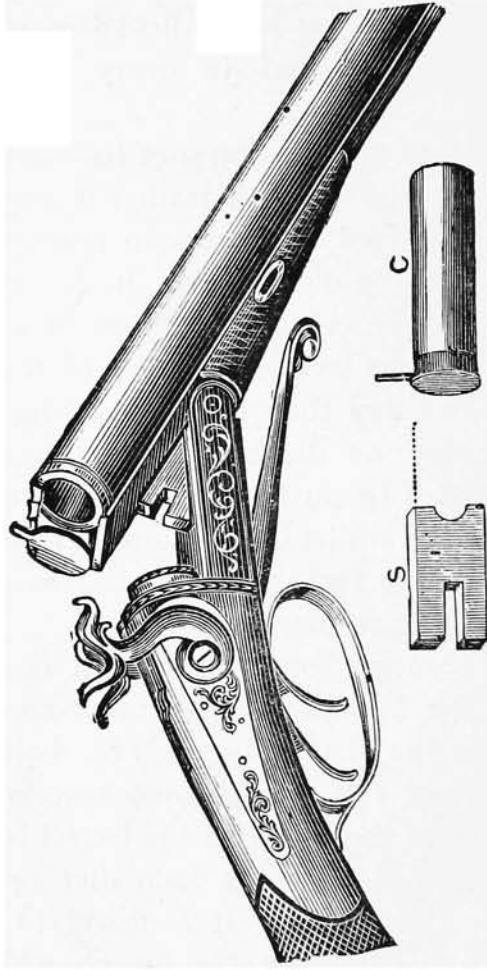

The Original Lefauchaux Breech-loader—1836.

down bolt. As may be inferred, this form of breech mechanism serves to hold the barrels down upon the bed of the breech-action body, but does not in the least secure the breech ends of the barrels to the face of the standing breech.

The firing of every charge exerts the greatest strength in a line with the barrels. The tendency is towards the barrels and standing breech being forced asunder, and consequently the two should be bound together as solidly as possible. Unless provided with some specially designed mechanism the gun on every discharge will open at the joint through the springing of the metal of the breech-action body, which cannot be made of sufficient strength and substance to prevent this movement although the better the metal and construction the less is the gaping. Every gun provided with a holding-down bolt only will, as a result of wear, gape permanently at the breech, and longer use will increase the breach until it becomes absolutely dangerous to use the gun.

Of the many contrivances invented to prevent this gaping, none are so effective as the cross-bolt. A doll's-head, the frustra of a cone reversed and attached by a narrow neck to the upper rib of the barrels, is thought to act as a dovetail when dropped into a mortice in the standing breech. The expansion of the barrels on firing, although slight, is sufficient to lift the doll's-head clear of its bearing. It consequently is not of the slightest

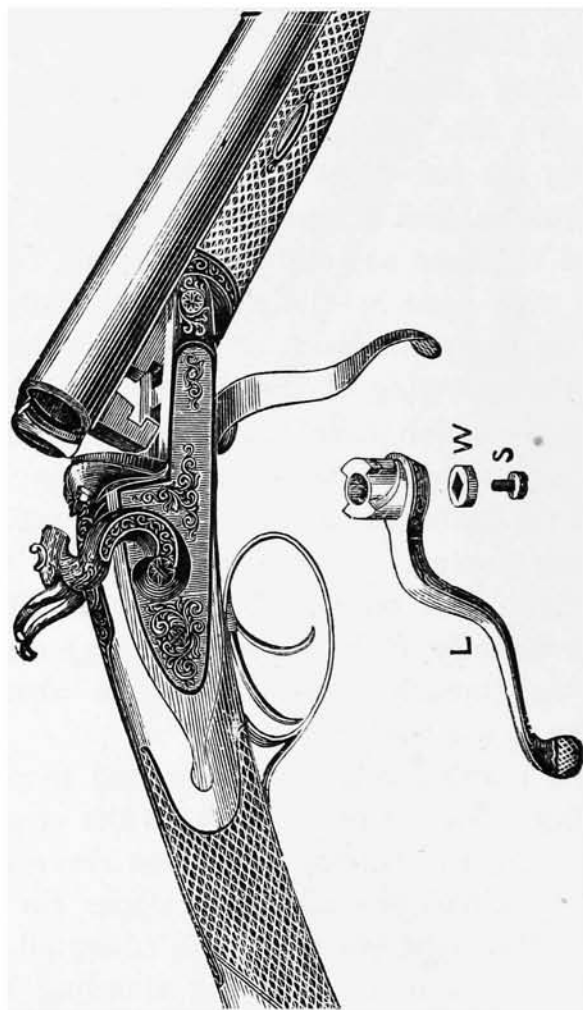

The Double-Grip Gun.

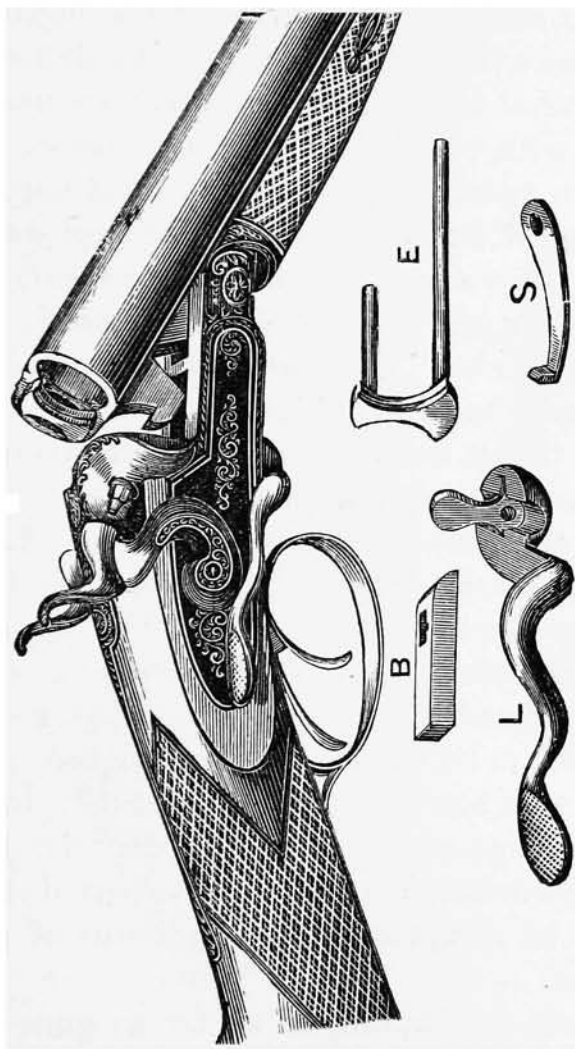

The Side-Lever Gun.

use as a binder, unless provided with an efficient holding-down bolt, engaging with it as in the treble-bite breech-action ; or, better still, it is provided with a substantial hook and a holding-down bolt, as in the well-known Westley Richards breech-action. Several forms of engaging bolt are used in connection with the doll's-head, but a better plan than all is to make the projection a plain one, and drive through it transversely a round steel wedge-bolt, which will secure the breech-action body and barrels together in the most effective manner it is possible to devise. This form of breech-action, properly made, has strength so much in excess of any barrels that it may be made with safety much lighter than any other, and protects the shooter in a manner no other mechanism can.

The well-known expert, "One who has Fired some 20,000 Shots at Marks," wrote to *The Field* that "in my opinion Mr. W. W. Greener's treble-wedge-fast cross-bolt action is by very far the strongest, the most durable, and consequently the best action that has ever been produced"; and as this opinion was endorsed by the late Mr. J. H. Walshe ("Stonehenge"), and every expert of standing, it may be accepted as the consensus of practical opinion.

The lock mechanism, in so far as guns with hammers are concerned, revolves itself practically into a question of taste. The bar, or front-action lock (page 23), is the one generally preferred, as it

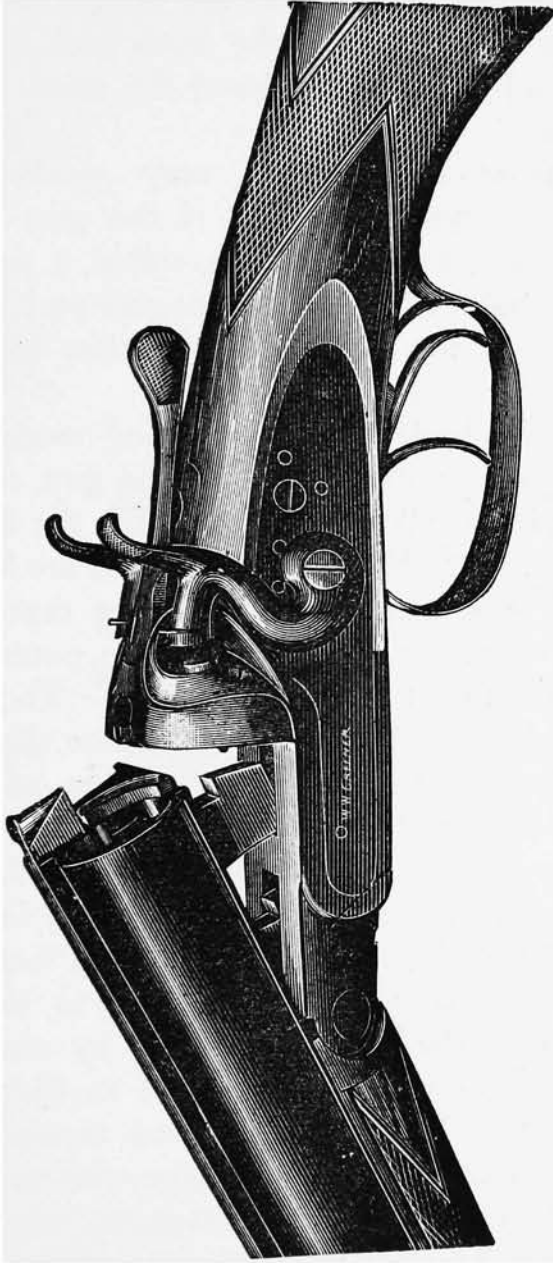

Doll's-Head Gun.

does not weaken the stock to the extent the back-action lock (page 25) and the back work-bar lock do, and it is by many considered the most elegant form of gun.

The front-action lock may weaken the action to a dangerous extent if the gun is improperly made, but, as already stated, a properly made cross-bolt action is the strongest part of any gun, and with this form of mechanism bar-locks may be used advantageously.

In the hammerless guns the firing mechanism, instead of being arranged outside the gun, consists of fewer pieces, all contained within the breech-action body. The hammerless systems are legion; they date in the present breech-loading central-fire form from 1860; but Mr. Murcott's gun, patented in 1871, was the first to become popular. The locks were cocked by the lever used to actuate the holding-down bolts of the breech mechanism, and four years after its introduction its successor, the barrel-cocker, was patented by Messrs. Anson and Deeley, the inventors. Instead of using manual force to compress the mainsprings, and cock the locks, the weight of the barrels when falling to load is utilised to raise the lock to full cock by means of levers pivoted on the same centre as that upon which the barrels are hinged, and turning with them. These cocking-levers engage with the arms of the tumblers (or hammers), extended forward for that purpose. The lock mechanism, tumbler springs,

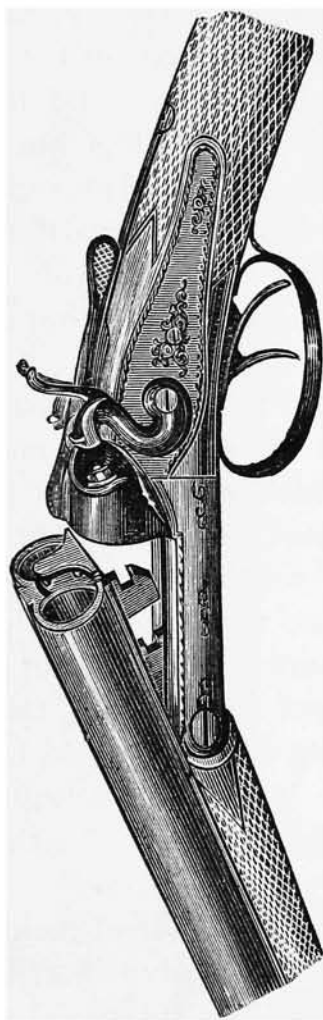

Top-Lever Gun, with Back-Action Locks.

scar, &c., is of the simplest and strongest design, and is arranged in slots cut in the breech-action body beneath the barrels. Of the various modifications of the Anson and Deeley, that improved form, known as W. W. Greener's *Facile princeps* mechanism, is the best known and most popular. There is in this no cocking-dog, but the forward ends of the tumblers are turned in, and engage with either a cocking-swivel pivoted in the under lump of the barrels, or by a sliding-rod abutting against the iron of the fore-part, and working in the barrel-lump and turning with the barrels.

Some guns on the hammerless system are made with the lock-work arranged upon, and affixed to, side lock-plates, similar to those of a hammer gun. It is claimed for these locks that they permit of the mechanism being readily inspected; but there would seem to be no advantage in this, providing the mechanism works well without constant inspection or frequent repairs, and the alternative method of arranging the mechanism in slots within the breech-action body has advantages which greatly outweigh those claimed for the detachable locks.

A weakness of several barrel-cocking mechanisms lies in the fact that a very short breech-action body is necessary to their successful working, and the author has now a gun which, whatever the length of body, works well and easily. The lock mechanism consists of a tumbler and scar pivoted



The Treble-Grip Bar-Lock Gun.

in the breech-action, the cocking being effected by a sliding rod, capable of a reciprocating motion, and mounted in a hole drilled diagonally from the hinge joint to the back of the body; one end of the rod is slotted to engage in a projecting stud in the tumbler, the other, having a larger diameter, forms a shoulder against which one end of the coil mainspring presses; the extremity of the rod projects through the knuckle of the action, and presents an inclined and rounded nose to the back extremity of the fore-end iron; a recess is made in the fore-end iron, in which, when the tumbler is down, the cocking-rod is freed. Upon the barrels being dropped for loading, the rod is pushed backward, and the gun thereby cocked. Upon the gun being closed and fired, the rod moves forward carrying the tumbler with it, and, having entered again the recess in the fore-end iron, it is once more ready for cocking.

There are also guns which rebound to full cock, and by closing the barrels the extra pressure requisite to give the downward blow is given to the opposite arm of the mainspring. There are also guns which are normally at full cock, and require pressure to be put on the mainspring by other leverage—such as gripping the gun for firing before the lock can fire; but neither of these principles can be recommended in preference to those already described.

Modern guns of the highest class eject the fired



W. W. Greener's Patent Treble-Wedge-Fast Gun.

cases, throwing them clear of the gun immediately it is opened if they have been fired, withdrawing them a quarter of an inch or so only if they are loaded. A separate extractor is used for each lock ; the tumbler of each lock, when the trigger is pulled and it is freed, falls into such a position that the extractor mechanism will engage with it as the gun is opened, and the fired cartridge be thrown clear of the gun. This is the principle of the double ejector gun, the idea of which originated with Mr. J. Needham ; and the principle has been adopted by all makers of ejecting guns, though the modification of the Needham mechanism, as improved by Mr. W. W. Greener, remains the simplest and most perfect form of self-acting ejector.

The cocking mechanism of the W. W. Greener automatic ejector is substantially the same in principle as that of the *Facile princeps* already described, but the cocking swivel is furnished with a stud, situate about midway between its extremities, and immediately beneath this stud the lower extremities of the ejecting levers are arranged so as to project. Presuming that the gun has been fired, the action is as follows :—On opening the barrels, the tumblers are raised by their turned-in extremities bearing on the additional stud of the cocking swivel ; when raised nearly to full cock they slip past this stud, and fall sharply on the lower arms of the ejecting levers, and the extractors, already withdrawn by the usual

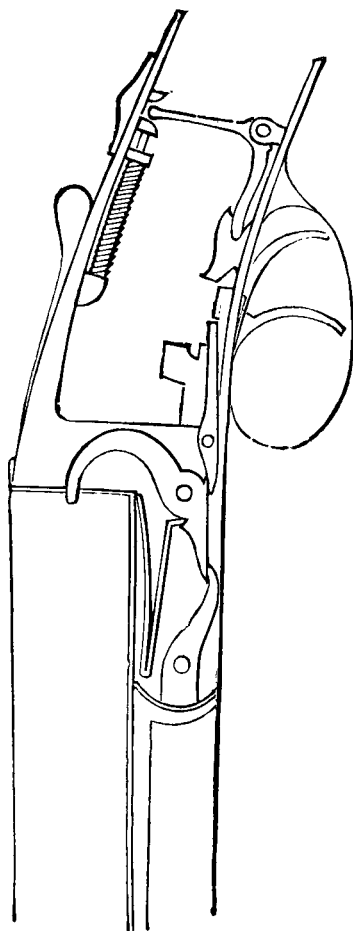

Anson and Deeley Hammerless, showing Lock Mechanism and Trigger
Bolt Action Safety.

extracting mechanism to the ordinary extent, are violently propelled to their full extent by the force of the blow, and the empty cases are flipped out. If one cartridge only be fired, the other lock remaining at cock does not engage with the cocking swivel or put the ejecting mechanism in motion; consequently, unfired cartridges are withdrawn to the ordinary extent in the usual manner. The available power for ejecting the fired case is that of the mainspring falling; the mechanism effects the ejection perfectly.

This gun requires most careful adjustment, and although the parts are few, simple, and very strong, to ensure their perfect working the utmost precision is necessary in centreing, shaping, and adjusting the various limbs. The gun can be made by highly-skilled workmen only, and must necessarily be of the best quality throughout.

Another form of ejector is that in which a separate lock mechanism is provided to effect the ejection of the fired cases. The best known gun of the type is the Deeley ejector, in which the additional lock mechanism is placed in the forepart of the gun, and consists practically of a second lock, with hammer, scear, mainspring, scear-spring, &c., which is cocked by the action of closing the gun, and when the gun is fired the "travel" of the mainspring is utilised as an automatically acting trigger to release the scear of the ejector lock, and leave it free to act by its tumblers

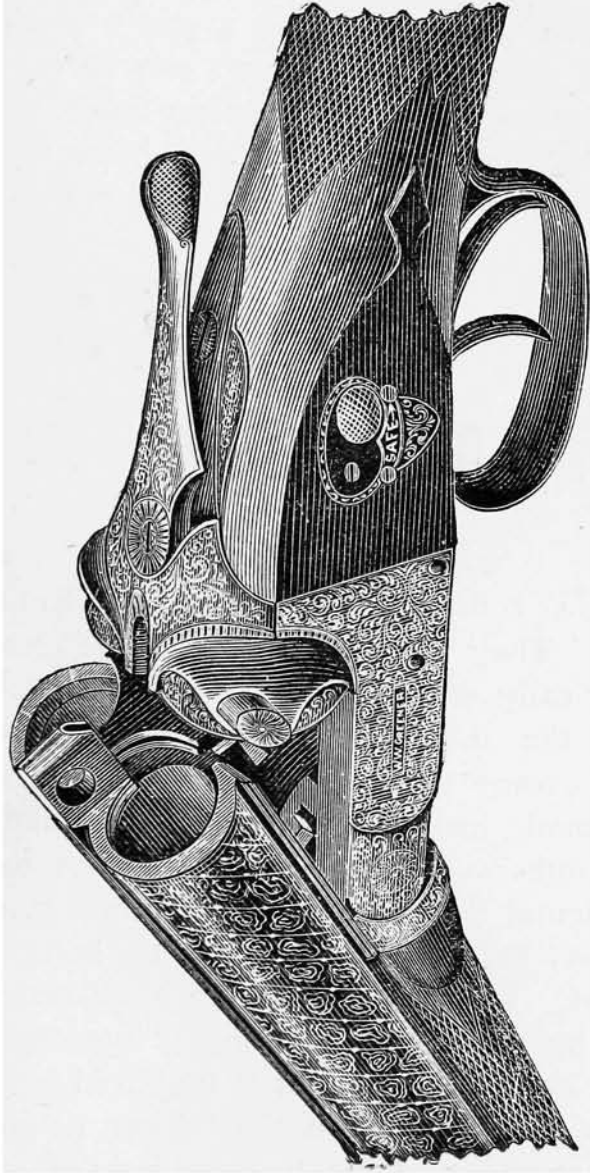

W. W. Greener's Treble-Wedge-Fast Hammerless Gun.

striking the leg of the extractor upon the gun again being opened.

Of the other parts of a gun's mechanism it will be necessary to refer to one only. Hammerless guns and some hammer guns are provided with safety bolts. The object of these mechanisms is to protect the shooter and others

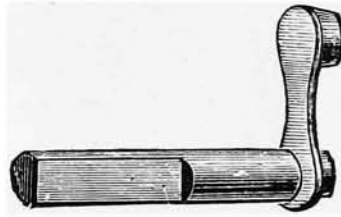

Greener's Trigger Safety.

from the consequences of an accidental discharge. They are of various kinds: some act automatically, others require to be moved on and off by the user of the gun; some lock the tumblers, some the sears, and some the triggers. A well-made hammerless gun is safer than a gun with hammers—that is to say, it is not so liable to accidental discharge as the hammer gun; consequently, the necessity for safety bolts is not apparent. To make doubly sure, a self-acting bolt, which, by means of a spring, “intercepts” the tumbler or hammer, should it be jarred from cock, is often provided; when the trigger is pulled, it also is moved, and the tumbler, instead of being caught by it, is free to reach the cap or striker. A

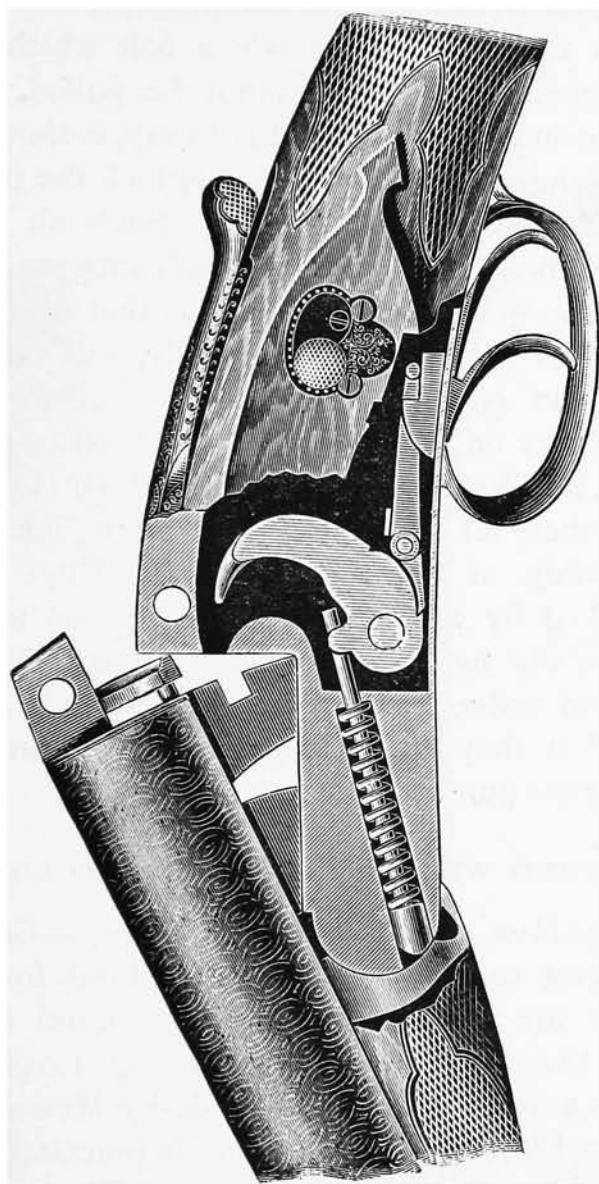

Greener's "Sovereign" Hammerless Gun.

second sear, acting quite independently of the primary sear, effects the same purpose.

It is also usual to provide a bolt which locks the triggers so that they cannot be pulled. This should be independent—that is to say, it should not be so arranged as to automatically lock the triggers every time the gun is opened. Such an article is a nuisance, and lessens the advantages of the hammerless gun. A safety, such as that illustrated, which bolts the triggers effectually, and is easily put on and off with the thumb, is much better than a safety on the top of the break-off or grip of the gun, as illustrated in the A. and D. Hammerless, for these all weaken the gun-stock, some very considerably, at its weakest point. Those which are worked by a spring to put them on and off automatically by gripping the gun are likely to get out of order, and not be “on” when it is expected that they are. They also prevent one from carrying the gun with comfort.

STANDARD WEIGHTS, LENGTHS, AND LOADS.

Large-Bore Guns for Wild-Fowling.—Guns of the largest calibre which can be fired from the shoulder are usually made single barrel and of 4-bore, the average diameter being 1.052 inch. There is a 2-bore paper case made by Messrs. Eley Brothers, Limited, but the calibre is practically that of the 4-bore thin brass case gun. The cases do not hold a larger charge, nor do the guns shoot

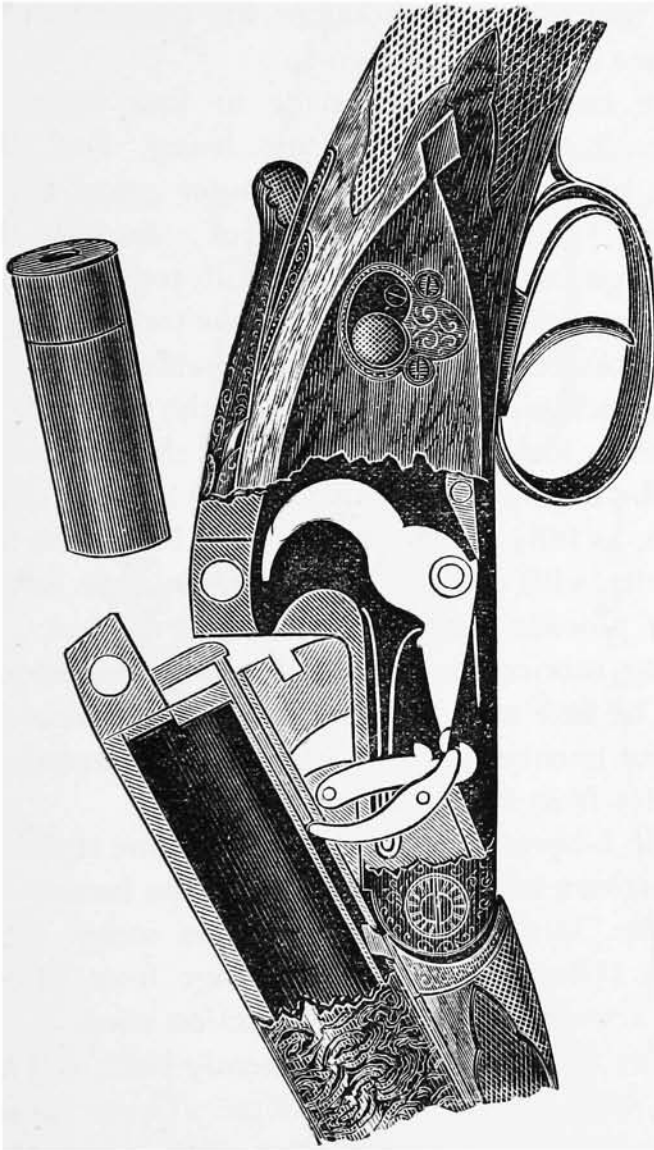

Mechanism of Greener's Ejector Gun.

better, if so well, and the cartridge-case has not the advantage of being so perfectly water- and damp-proof as that of brass ; therefore, the 4-bore gun for brass cases is that recommended.

These large guns are made in four styles of breech-loading, the mechanisms being, first, the cheapest, with double-grip lever under guard, back-work lock, and outside hammers ; second, the treble-wedge-fast, with top cross-bolt, top lever, bar lock, and outside hammers ; third, the treble-wedge-fast top cross-bolt, hammerless mechanism ; fourth, similar breech mechanism, but with the addition of self-ejecting lock work. The gun should weigh from 15lbs. to 18lbs., the barrels being 42in. to 46in. in length, as fully choked as possible, to obtain the best results, with charges varying from nine to ten drams of powder, and $3\frac{1}{4}$ to $3\frac{1}{2}$ ounces of shot.

Strong serviceable guns, with first-class shooting, can be had with the cheapest form of breech-actions for twenty guineas, and with the hammerless ejector from forty guineas.

Single 8-bores are made with the same styles of breech-actions as described above. The barrels are made 36in. in length, and the guns weigh from 12lbs. to 15lbs., and the prices range from fifteen guineas, according to the breech-action used.

Double 8-bore guns are frequently built, and are popular with expert wild-fowlers. These should have the barrels not longer than 36in. when they weigh about 15lbs., or $13\frac{1}{2}$ lbs. to 14lbs., with barrels



The Deeley Ejector Gun.

two inches shorter, and only 12lbs. with barrels 32 inches long. The charge varies from 6 to 7 drams of powder, and the standard charge of shot is $2\frac{1}{2}$ ounces, which should not be exceeded unless very large swan shot is used. Such guns can be made considerably lighter if they are intended to be used with a smaller charge of shot. Double 8-bore guns cost £5 5s. more than 12-bores of corresponding styles and qualities. They are full choke, and the thin brass or "Perfect" cases are recommended in preference to all others for guns of 8 and 4-bore. These cases take the large charges better, and it will be found generally advantageous to use black gunpowder only ; better results accrue than from the use of any nitro-compound, and it is safer, as heavy loads of shot increase the strength developed by nitro-compounds to such an extent that black gunpowder is preferable, even on the score of safety alone. Cheap 8-bore guns are not to be recommended ; many light and inferior weapons are offered, the shooting of which will not equal a good 12-bore, even though double the charge of shot may be used. It is not merely the size of the bore which gives superior shooting ; everything must be in proper proportion to these. The uselessness of a large gun, which, although heavier than a 12-bore, has neither its range nor its shooting qualities, is so apparent that it seems superfluous to add that very often cheap large-bore guns will not withstand the heavy charges

which it is customary to use in arms of this calibre.

The 10-bore has been for some years the favourite size for a duck gun, and regarded as the best size for the wild winged game of America. Of late it has fallen out of favour, and it is remarkable how quickly the 12-bore is supplanting it in the United States. The common type of 10-bore was 10lbs. or more in weight, with 32in. barrels, and was used with a charge of 5 drams of powder and 1¼oz. of shot: a charge in which the quantity of powder is out of proportion with that of the shot used. The most generally useful type of 10-bore is that of 8½lbs. to 9½lbs. in weight, firing either brass or paper cases, and using as the standard charge 4 drams of powder and 1½ oz. of No. 4 or larger size shot. Such advantages as the 10-bore possess are obtained from the use of large size shot; for use with small shot, a 12-bore of 7½lbs. to 8lbs., and loading 1¼ oz. only, the smaller gun is quite its equal. 10-bore guns cost £1 1s. more than 12-bores of the corresponding styles and qualities.

The Standard Size for Game and Trap.—The 12-bore gun is, and in all probability ever will be, the standard calibre. The ordinary game gun of this bore should not weigh more than 7¼lbs., but heavier guns, of 8lbs. to 8½lbs., having 32in. barrels, are much used in America for rough work, being chambered for 2¾in. or 3in. cartridge cases. They make capital duck guns when loaded with 1⅜oz. to

$1\frac{1}{2}$ oz. of large-sized shot. The favourite pigeon gun for trap shooting is just under 8lbs. in weight, and has 30in. barrels, chambered for $2\frac{3}{4}$ in. cases, and regulated to shoot a charge of $3\frac{1}{2}$ drams and $1\frac{1}{4}$ oz. of shot, and when choked to the fullest is a perfect weapon for a strong man whose handicap distance is thirty yards. This style of gun is used by Captain Brewer, who in one match fired at 250 birds, and his opponent, who made the highest score on record (199-200), used a gun $\frac{1}{2}$ lb. lighter, but in other respects similar. The $7\frac{1}{4}$ lb. gun of this bore should have 30in. barrels, chambered for the ordinary paper cartridge case, $2\frac{9}{16}$ in. long. The standard load will be 3 drams and $\frac{1}{8}$ oz. of shot, which may with advantage be increased to $3\frac{1}{4}$ drams and $1\frac{1}{8}$ oz. when birds are wild. The gun should also shoot well with $3\frac{1}{4}$ drams and $1\frac{1}{4}$ oz. : a load suitable for pigeon shooting. The 12-bore can be made with 30in. barrels, 7lbs., $6\frac{3}{4}$ lbs., and even $6\frac{1}{2}$ lbs. in weight. If so light as $6\frac{1}{2}$ lbs., one barrel should be cylinder or only modified choke. With 28in. barrels, $6\frac{1}{2}$ lbs., $6\frac{1}{4}$ lbs., or 6lbs. ; with 27in. barrels, as light as $5\frac{3}{4}$ lbs. ; and with still shorter barrels the weight can be proportionately lessened.

Guns of 12-bore are made of every quality. A sound serviceable gun may be obtained for £10, or if hammerless, from about £15. Fine guns and ejector guns cannot be purchased under £35. The ordinary type of gun, of reliable quality throughout, well made, and fitted well, costs about £25. The

reason for the difference in prices and qualities is more fully explained in the succeeding chapter on the choice of a gun.

Guns of Small Bore.—The 16-bore gun was at one time a favourite size with Continental sportsmen, who now for the most part prefer the 12-bore, and for use in England certainly not more than one gun in every five hundred is of 16-bore. The 16 calibre has been proved to shoot as strong as the 12, but the killing circle is less, and, moreover, not being in such general use as the 12-bore, it is not always so easy to procure cartridges in out-of-the-way places, or, in the event of running short of borrowing a supply of a friend. The standard weight for 16-bore was $6\frac{1}{2}$ lbs.; and the barrel, 30 inches in length, regulated to shoot $2\frac{3}{4}$ drams and 1 ounce of shot, or with 28in. barrels, $6\frac{1}{4}$ lbs., but 6 lbs. is now considered to be quite heavy enough for any 16-bore, with 28in. barrels. The one advantage of the 16-bore is its lightness, and when built in the same fashion as the miniature 12-bores, they may be $5\frac{1}{2}$ lbs., with 28in. barrels; $5\frac{1}{4}$ lbs., with 27in. barrels, and about 5 lbs., with barrels as short as 26in. The lightest 16-bore the author ever made had 25in. barrels, and weighed $4\frac{3}{4}$ lbs. only.

The 20-bore has been strenuously advocated by writers in the sporting papers, but there are very few sold—the proportion is perhaps one 20-bore to twenty of 16-bore. The 20-bore should not have

barrels longer than 28in., nor should it be heavier than $5\frac{1}{4}$ lbs., and the full standard load is $2\frac{1}{4}$ drams and 1 ounce of shot. They can also be made 28in. barrels, 5lbs.; 27in., $4\frac{3}{4}$ lbs.; 25in., $4\frac{1}{2}$ lbs.; and so on in proportion.

In the 1875 Gun Trials, W. W. Greener's gun was first in the class for 20-bores with a gun using only $2\frac{1}{8}$ drams of powder and 1 ounce of shot, beating in both pattern and penetration heavier guns shooting larger charges. A frequent error, and one which is of importance, is the overloading of small-bore guns, for sportsmen overlook the point that the gun does not fail to kill owing to a lack of penetrative force, but because the pattern is not sufficiently close. With moderate charges the penetration of any well-bored gun is sufficient.

The 28-bore was brought prominently into notice by "Young Nimrod," the boy-shot, who, before he was in his teens, did wonderful shooting with a little 28-bore gun made for him by W. W. Greener. It may be judged how tiny was this young expert when we say that the stock measured only $11\frac{1}{2}$ inches from the fore-trigger to the butt. The 28-bore is loaded with $1\frac{1}{2}$ drams and $\frac{3}{4}$ ounce of shot, No. 7 or 8 by preference, as with small shot the spread is increased; and such guns are not intended for shooting at long distances, although Sir Frederick Millbank killed a pheasant at fifty-three yards with one the author made for him, and also killed a hare "stone dead" at

thirty-four yards, the charge used being $1\frac{1}{2}$ drams of black gunpowder and $\frac{3}{4}$ ounce of No. 6 shot. In public matches "Young Nimrod" was placed at twenty-seven yards from the centre trap, and on more than one occasion killed thirty-eight out of fifty of the best Blue Rocks.

Small-bore guns require great care in every stage of manufacture. It is always advisable to buy them of the best makers, and it cannot be too often reiterated that cheap light guns should be avoided; and more especially is this the case with small-bores, for in them the material must be of the very best, the internal pressure exerted in the barrels of small calibre being greater in proportion than that of larger bores; and the same rule applies whatever the proportion of the loads.

Guns of Odd Size.—Guns of 24 and 32-bore have been made—as, indeed, have 14-bore guns; but so rarely are they made, and of such little utility are they, that they may be dismissed with the merest mention. The 28-bore is the smallest of any practical use as a game gun, but the 410 and other sizes are suited to the requirements of naturalists, and for such weapons as walking-stick guns.

Remarks applicable to all Guns.—The weights given, except where stated to the contrary, refer in every case to double-barrel guns. Single guns can of course be made lighter, but there are gun-makers, with no reputation to lose and nothing at

stake, who recommend 28-bores, weighing less than $4\frac{1}{4}$ lbs., for brass cases to take loads of 2 drams and 1 ounce: in our opinion a charge altogether out of proportion to the calibre of the weapon, and the use of which may prove as dangerous as the recommendation is mischievous.

All guns, with the exception of 4 and 8-bores, if properly constructed and regulated, will shoot the thin brass "Perfect" cartridge cases quite as well as they do the ordinary paper case. The chambers for the two are identical, and, although previously the author made guns with a larger bore in order to correspond with the increased internal diameter of the thin brass cases, he has discontinued so to make them for two reasons: First, guns so bored shot very badly with paper cases; also very badly with nitro powders.



CHAPTER II.

ON THE CHOICE AND FIT OF A GUN—SPURIOUS, SHAM, AND SECOND - HAND GUNS — THE QUALITY, PRICE, AND MANUFACTURE OF GUNS—THE GUN THAT WILL SUIT — ORDERING BY LETTER—CHOOSING FROM STOCK.

THE choice of a gun should be determined, first, by the purposes for which it is intended to be used ; secondly, by the physique of the person by whom it will be used.

It will be preferable to preface the considerations of these particulars by some general advice respecting the purchase of guns generally.

There is, in the first place, much misconception as to the value of guns, and to the casual observer there is often no perceptible difference between a fairly good gun and a really good one ; often the experienced sportsman finds himself imposed upon as readily as the tyro. In order to distinguish a good weapon from one which appears good, it will be necessary to examine minutely into the details of its construction, and anyone who carries out the instructions given here, and will carefully observe the points indicated, need not fear to make a purchase upon his own estimate of a gun's worth.

Do not, therefore, purchase any gun without first examining it, unless from a person of whose standing you have no doubt, and who will agree to exchange the weapon or return the money, if required. The purchase of a pig in a poke is always attended with risk, which no respectable dealer or gun-maker requires a customer to run. Many advertisements of the "catch-penny" type appear in the general newspapers, and are occasionally found in the columns of the sporting press. Offers of guns at an extremely low price will not delude the common-sense man into parting with his money. Some people, in the hope of securing a bargain, get caught on the well-baited trap; less frequently the reckless advertiser is prosecuted and convicted. The following specification, copied from a gun-maker's list, is a never-failing catch:—"12-bore gun, laminated steel barrels, left choke-bored, top-lever, snap-action, purdey double bolt, extended rib, rebounding, and low hammers; patent fore-end, figured walnut, half pistol-hand stock, horn heel-plate, scroll engraving. Price, 60s." The same description might be applied to a sixty-guinea gun with as much truth. Until a sportsman knows something about guns he should purchase of a respectable maker. Even "friends" will seek to benefit by a young man's inexperience more frequently than will the dealer, who wishes to secure his custom, and looks forward towards future orders as well as to present profits.

Take first in hand the cheapest gun made for the wholesale trade. Such a gun is not usually found in a country gun-maker's shop; but it may be offered to a quite inexperienced buyer. To all appearances, the gun is as others. It has two barrels, locks, triggers, a stock well varnished, and has a new look about it, which may be mistaken for "finish." Let us examine the gun carefully. The parts, as the bed of the breech-action body and the lock-plates, which should be flat and square, are rounded, and the surface uneven and scratchy; parts, such as the knuckle-joint and the barrels, which should be round, are also uneven, irregular, and have flats upon them; the hammers are not a pair, and when placed down upon the nipples, at half-cock and at full-cock, will be found to stand parallel in one position only. In cocking the locks, one will "squeak," the other will make no sound, one striker will push outward and upwards, the other at a different, but not a corresponding, angle. The extractor may have a crooked leg, and will probably be rusty underneath. Wherever two parts come together there will be a wide joint and no close fitting. The action body barely touches the barrels. The holding-down bolt is a crooked contrivance in a crooked hole. The fore-part will drop from the gun when fired, or cannot be pulled off however gripped. The stock will show marks of file-teeth, and probably exhibit a rough open grain through the varnish or "oil finish." The chequering will be

irregular, the lines overrun, and several of the diamonds missing. The engraving will consist of ill-shapen, deeply-cut furrows and meaningless scratches, put on by the dozen with a shading-punch. The butt-plate will be of pressed rubber, and probably have a sporting design, in high relief, stamped upon it. The rib will be crooked, irregular, uneven, and probably more on one barrel than on the other, instead of midway between them. All these faults arise from the "cheapness" of the article. The work is scamped, and the gun will give no satisfaction, at whatever price it may be purchased. On trial, it may fail to go off, the striker being too short or not central. This rectified, it may be found that the other striker is too long or too sharp, so that after the gun is fired it cannot be opened. This is altered, the mainspring is so poor, its elasticity has departed, and mis-fires ensue. A new mainspring is fitted, and from the time this first new piece is fitted the old ones break in turn, until at last the barrels drop apart, owing to having been soldered with sal-ammoniac as a flux, instead of resin, and a new gun has to be purchased.

A serious danger arises from the use of too long strikers in hammer guns. The striker is so near to the hammer face at half-cock that a blow upon the hammer will discharge the gun. Very cheap guns are usually very defective in the breech-action fitting, and if this is not a source of immediate

danger, the gun being, *to some extent*, safeguarded by the compulsory proof, the mechanism will soon fail. In like manner, parts of the lock mechanism, instead of being of hardened steel, will be made of common iron, and tumblers and screws are so soft that in a very short time the heads become worn, and the hammer will not stand at cock. The danger that accrues from the use of such a weapon is so great that this cheap gun may be regarded as increasing the risks of shooting a hundredfold.

A gun, however poor in principle, if not of inferior workmanship, is worth purchasing at a price, and the quality of workmanship is indicated to the tyro by the attention paid to details: as, for instance, the proper smoothing of the iron-work, the close fitting of wood and iron, the pitch of the strikers to correspond with each other, and the hammers made to stand each as high as the other at both full and half-cock, the extractor well made, and closely fitted, and smoothed underneath; the rib is put on properly, its edge will appear to be level, its surface flat and regular, and the engraving of some design. In better grades there is a smoothness and flatness of the lock-plates that is at once noticeable, and if the thumb is drawn lightly round the barrel it will not detect those flats, which even the eye cannot see. The pins will be carefully fitted flush with the surface, and the slits in them regular as to size and depth, and lying all one way. Unless attention be given by the workman to every

piece, no matter how seemingly unimportant, the gun is not well-made, and may fail just where least expected.

The machine-made and machine-finished gun may be distinguished: First, by its rough "metallic" appearance; second, the heads of the screws will be found to be rounded down, not filed off flush with the lock-plates, breech-action, butt-plate, etc., the slits of the screws lying at different angles; third, inequalities in barrels and rib; fourth, the stock shaped like an army musket. In hand-finished machine-made weapons many of these irregularities will not be noticed; but as long as the gun is interchangeable, many matters in construction and finish have to be sacrificed, and, as a general rule, the further removed a machine-made gun is from interchangeability the greater is its worth.

The spurious gun may be either a gun represented as being of a quality it is not, or as a production of a maker other than the real one. After taking all into consideration, it is the first class which is the most dangerous to the unwary buyer. The vapid platitudes of the salesman spread a glamour over the transaction, and the sportsman purchases a gun which will trouble him more and more as he gets to know it. Against the purchase of this class of gun the sportsman must always be on his guard.

The second class of gun is simply a forgery. Belgian guns are sent to England to be proved, or

the English proof marks are imitated; "English fine twist" is engraved upon the rib, or *any* maker's name is put on to the order of the importer.

All the leading makers, or their retailers, now advertise, so that the exact name of the maker wished is easily obtained. See that the gun bears this name, and rightly spelled, for the change of a letter is often made, the maker of the forgery thinking that his liability is lessened; and foreign forgers make dreadful havoc with English names, whereas probably no careful maker has ever turned out a gun wrongly or incorrectly named, so far as HIS name goes.

As to the more general forgeries, they will be found to be changes rung upon the name of a maker of reputation. No one would forge "Smith" or "Jones," and happy the gun-makers who possess such names; but names as "Greener" will be spelled "Greenen," "Purdey" as "Purdy," "W. C. Scott & Son" as "J. N. Scott's Son"; whilst of the imitation of "Westley Richards" the name is legion. The alteration in the initials of the Christian name or address is more frequent, and all "Horace Greener," "Albert Greener," "J. H.," "W. H.," "A. H.," and other "H. Greener" guns are practically forgeries.

Before purchasing a second-hand gun, unless you know its history or are well acquainted with the person offering it write to the makers of it, give its number, and ask, as a favour, to know its

original list price and the date of its original sale ; the gun-maker will never refuse this information. If the gun has been stolen or lost, and he is acquainted with that fact—as he probably will be—you will at once be advised, and in any case the information he gives will prevent you from being induced to part with more money for the gun than it actually cost when new. Many succeed in making money out of the purchase of cheap guns, which they use for a few times, and then offer as second-hand weapons of very superior quality.

Gun-makers who sell guns ranging from ten to fifty guineas not unfrequently have slightly-used guns of their cheaper qualities represented as being of their best make, and instances are on record of guns purchased at the full retail price of fifteen guineas being sold as a bargain at twenty-five pounds when second-hand. It is far better to go to a respectable maker, who has a reputation to keep up, and purchase a new gun at from ten to fifteen guineas, than lay out the same amount on a second-hand one, which may be worn-out. There are numbers of makers in Birmingham who can supply good guns at the above price.

Shop-soiled guns, with various faults, blemishes, and sometimes guns with serious defects, are sold to dealers in second-hand goods, are sent to auction sales, or, as a last resource, are pawned ; so the purchase of a second-hand gun is even more risky than buying a horse in market overt.

OF THE MANUFACTURE OF GUNS.

The quality and cost of modern guns are chiefly dependent upon the design and workmanship of the weapon; the most expensive to manufacture being ejector guns.

The material employed in the manufacture of sporting guns is usually the best procurable, but as this material is capable of being improved by the proper manipulation of the metal in the processes which are necessary to convert it into gun-barrels, there is, and must be, a wide divergence between the prices of a good serviceable gun-barrel and one of the first quality. With respect to Belgian barrels, they are made of much softer metal than English Damascus barrels; they will not stand full choke-boring, and so soft and yielding are they that they bulge at the choke when fired, and cannot be made to retain their shooting qualities. These remarks apply to all qualities of Belgian Damascus barrels.

OF ENGLISH GUN BARRELS.

Of English Twist barrels there are two types—the machine-made, which have a rather coarse appearance, and often present irregularities of the figure; and the hand-welded barrels, which contain a larger percentage of steel, and are now very difficult to obtain.

The best hand-made English Damascus, or laminated steel barrels, are made at Birmingham

only, and are, without a doubt, unrivalled the world over for beauty, durability, and reliability.

These barrels are closely imitated by Belgian workmen, and find a ready sale in this country, especially amongst the London gun sellers.

The "figure" of the barrels may be recognised from the illustrations in this book, and when examining a barrel of this kind, if the figure is regular, small, and light in colour, they may be regarded as of good quality.

Steel of the right quality has been found to possess sufficient strength to resist the strain to which a shot-gun barrel is ordinarily subjected.

The safety of the weapon with any charge should be guaranteed by the English Government Proof House: an institution for which the gun-maker is heavily taxed. As a matter of fact, the English Government Proof House test, which is even the most severe of any country, has long been useless as far as a guarantee of the gun's safety is concerned. Guns and barrels brought direct from the proof house have burst in the hands of gun-makers' assistants, or whilst otherwise undergoing such tests as the maker has thought needful to determine the safety of his weapons.

The proof mark, therefore, will not be taken by the buyer as of any practical value, although he will, of course, reject at once any weapon not possessing it. The guarantee of the gun's safety in this respect must be the name it bears.



London Proof-House Marks.



Birmingham Proof-House Marks.



Belgian Proof Marks.

BREECH-ACTIONS.

In the choice of breech mechanism a top-lever will certainly be decided upon; side and bottom levers will not be chosen, save for very special purposes, or to accommodate a sportsman habituated to this form of lever from long use. The top-lever so conveniently placed enables even the most determined adherent to any other form of lever to quickly and comfortably manipulate the breech mechanism. As to holding-down bolts and cross or grip bolts, and the number and position of the barrel lumps, the sportsman will demand two binding and well-fitted bottom lumps or lugs substantial in size, and the back lump so shaped as to correspond with the circular front of the slot in which it is embedded, and so well fitted that when the gun is closed and free this portion of the lump shall take a part of the strain. This matter of fitting the barrels is termed "circle jointing," and the accompanying illustration will convey a better idea of its nature than a verbal description. A gun so made will last longer and be stronger than a weapon with ordinary lumps; the need for more lumps at the bottom has never been proved, and the mere multiplication of them for the sake of complication is an error.

It is advisable to have a sound top connection between the barrels and the breech action. Such a connection adds greatly to the strength and life of

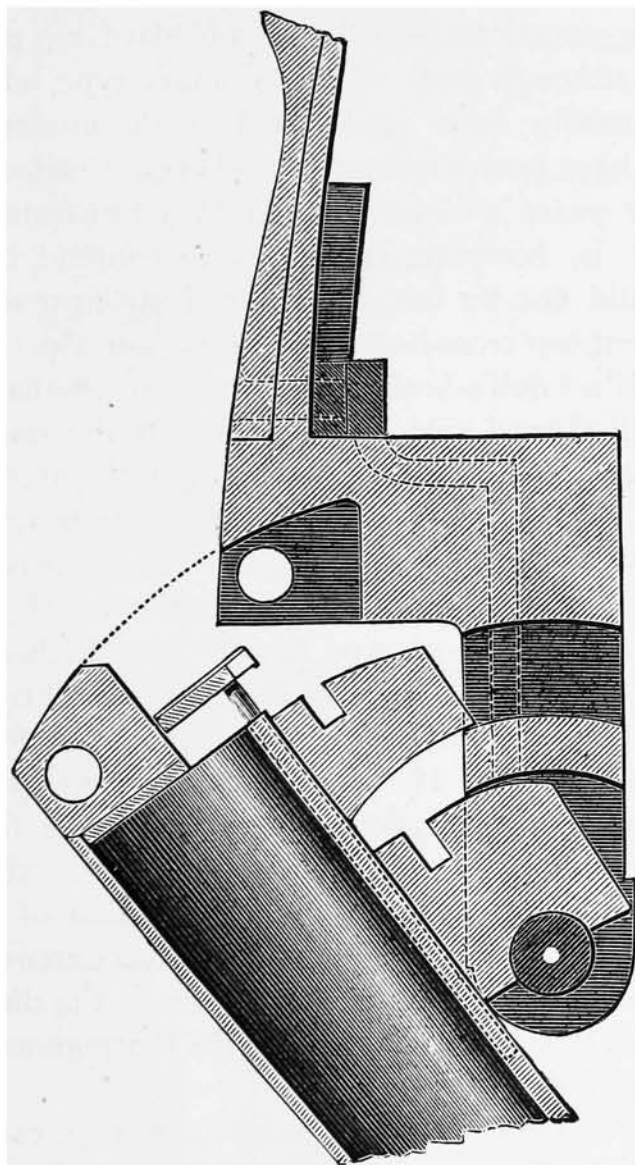

The Working and Bearing Parts of a Hammerless Breech-Action.

a gun, and is a protection to the sportsman in all cases. On arms of some descriptions it is practically necessary to provide an adequate top connection, although guns of the ordinary type, when very carefully built and used with moderate charges, have been known to stand even continuous wear for years without the aid of a top connection; it is, however, ridiculous to contend that they would not be better, safer, and stronger with an efficient top cross-bolt. The common top connection is a "doll's-head," fitting more or less badly into an ill-shaped hole, hollowed out in the standing breech to receive it. (See No. 3 in the accompanying illustration.) This useless encumbrance is affixed to guns to appease the ever-increasing demand for an efficient top connection which the success of the author's and the Westley Richards' mechanisms has produced. No. 2 of the illustration shows the Westley Richards', the best form of "doll's-head." The strain upon firing is in the direction of the arrow, but at the same time the expansion of the barrels conveys to the extension a tendency to move in the direction of the shorter arrow (A); the bolt into this top extension in some measure prevents movement in the direction of A, but much depends upon the manner in which the bolt is fitted.

The Greener Treble-Wedge-Fast Top cross-bolt makes the strongest breech action known. The bolt securely binds the breech ends of the

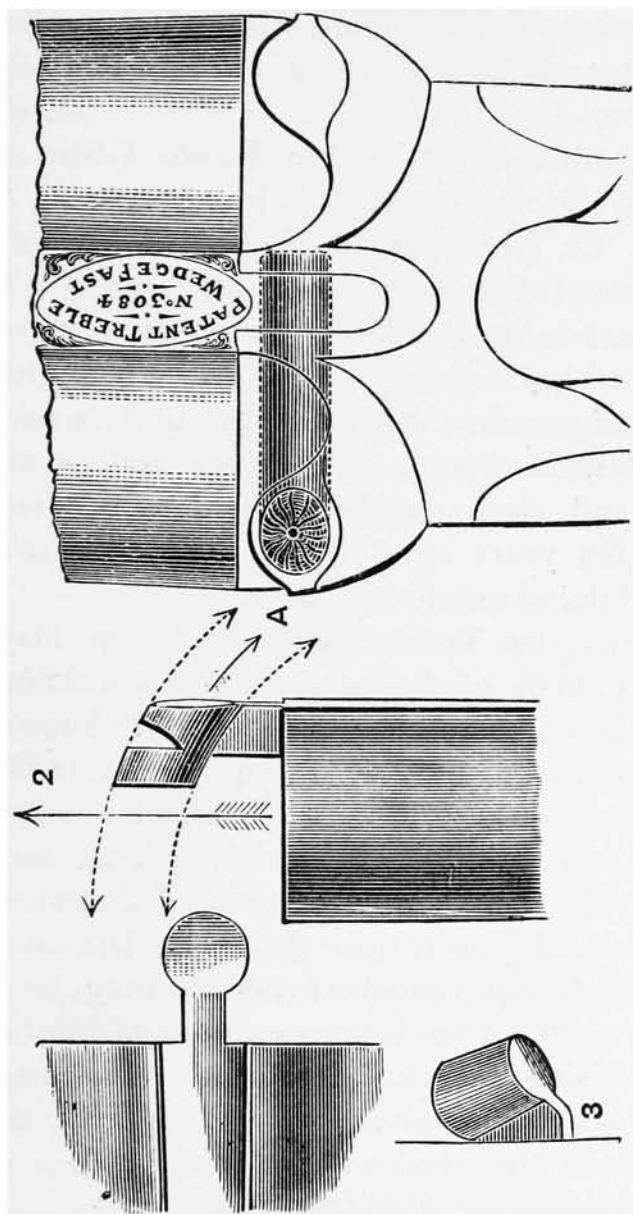

Top-connections between Barrels and Breech-Action Bodies.

barrels to the breech action body, and is worked by an arm on the top lever. It is far superior in strength and lasting power to the double-grip action.

A double 4-bore and a double 8-bore were made on this, the top cross-bolt principle, in 1874, for Mr. G. P. Sanderson, Superintendent of the Government Elephant Keddahs, Decca. They have been in continual use ever since, firing 2 oz. bullets with 12 drams, and 4 oz. bullets with 16 drams of powder "hundreds of times," and to quote Mr. Sanderson, "the breech actions are as sound and close as when they left the factory nearly ten years ago." These rifles are *still* in use and doing excellent service.

A Greener Treble-Wedge-Fast gun may be fired hundreds of thousands of times without any repairs being required. To the author's knowledge the gun he supplied to Dr. Carver in 1878 was fired one hundred and thirty thousand times without any repairs being done or required; and the gun is still in use, and has had possibly thousands of shots fired from it since the author last saw it.

With a top cross-bolt barrels may be fired together without the least possibility of the breech action giving way, and as this is a contingency that may at any moment accidentally arise, it is as well to be furnished with a gun that will stand both barrels being fired together.

The sportsman will choose a gun with top

cross-bolt, providing that he wants a gun that will fire any charge without the breech action giving way, providing he requires a light gun—a gun for very heavy charges—a gun for hard wear—a gun that will last him and always be satisfactory.

HAMMER, HAMMERLESS AND EJECTOR GUNS.

A hammerless gun is to be preferred to the hammer gun, as being safer to use and easier to manipulate. The hammerless gun is stronger than the hammer gun, less liable to damage, less complex in construction, more durable, in all more important particulars the superior of the hammer gun.

The hammerless gun of inferior make is as dangerous as the inferior hammer gun, if not more so; and in the choice of a hammerless gun the sportsman will be guided by, 1st, the simplicity of the mechanism; 2nd, the efficiency of the mechanical parts introduced to effect that hitherto performed by hand; and 3rd, the reputation of the maker whose name it bears.

All guns cocking by means of mechanism geared on, or in any way connected with, or dependent upon, the motion of the top breech action lever for effecting the cocking of the locks, will be at once rejected, because they are liable to miss fire if the lever does not snap "home," and because they are generally fitted with weak mainsprings, and often require great force to open.

Of those guns cocked by the falling of the barrels, or closing of the gun, will be rejected all that, 1st, do not permit of the barrels being placed readily upon the stock ; 2nd, that may be wrongly put together and so cause a breakage ; 3rd, that require a jerk to open or shut ; because all such guns will be an annoyance to the owner, and in the case of the last objection will cause undue wear at the hinge joint and need early repairs.

There are several guns which will fulfil every requirement of the sportsman so far as mechanism goes. The hammer gun notwithstanding the use of the rebounding locks, which saved the many accidents that resulted from the half cocking of the locks, cannot be so safe as hammerless, as hammer guns have been known to go off unexpectedly owing to a twig wedging in between the hammer at half-cock and the striker, and many more owing to wear or faulty construction have exploded when at the rebound by means of an accidental blow upon the hammer. The most common cause of accidental discharge in the hammer gun is when placing the gun at full-cock from half-cock, or the reverse, the hammer is likely to slip from the thumb and explode the cartridge. With some hammerless guns, nothing short of pulling the trigger can fire the gun.

However expert he may become in manipulating the locks and loading the gun, a sportsman armed with a weapon of the ordinary type is

heavily handicapped by the sportsman provided with an arm in which, without any trouble or extra exertion on his part, such processes as cocking the locks and taking out the fired cases are performed for him more quickly and more surely than they could be were he the most expert manipulator.

The self-cocking of the locks is in itself an immense advantage, and the self-ejecting of the fired cases, by reducing the number of movements to be made by the hands when loading, is decidedly worthy of support. The ejecting mechanism as made by the author has been tested in every quarter of the globe and under all possible conditions, it has been found thoroughly reliable in every climate, and is consequently recommended by all who have made use of it; at the present time it stands at the head of sporting guns, the nearest to perfection.

For speed the self-ejecting gun is ahead of all magazine or repeating shot-guns, and not only can it be fired more quickly, but it is free from any liability to "jam" when rapidly manipulated, whilst the repeating mechanism of shot-guns is more prone to "jam" than the mechanism of a rifle, owing to the use of paper cartridge cases turned down to various lengths.

THE PRICES OF GUNS.

Much nonsense is written, chiefly by sportsmen

who think they know all about trade matters, concerning the price of guns and the cost of producing them. In one book, which is intended as a work of reference for sportsmen, a detailed list is given of the cost of producing a gun, and to every item in that statement exception could be taken, and whatever its utility it may safely be asserted, that if the full value of every item there given be used in making one gun the result would astonish no one so much as the man answerable for that bill of costs.

A double barrel, central fire, 12 gauge breech-loader can be purchased wholesale for about thirty shillings, a best gun with hammers, a really sound, useful sportsman's weapon, is sold at sixty guineas by some makers, and will not be sold for less. The difference, it need not be said, is not for the name of the maker engraved upon it. The best gun, even when made in the centre of the gun-making industry, costs very much more to produce than sportsmen or critics suppose. The barrel is made of a splendid quality of metal, costing a fabulous sum per ton. In constructing a pair of tubes 18 lbs. will be used, and the metal will be worked at a red heat, and from its multitudinous welds, as well as from its inherent quality, will gain strength, *i.e.*, tenacity. This 18 lbs. of iron, by hand labour, has to be reduced to 3, and the superfluous metal must be removed just as and when required, or the barrel will be worthless. Through twenty-six

succeeding processes these tubes have to be handled, worked, and treated with care, and may, after receiving every attention human skill can devise, prove defective at the last moment, and instead of figuring in the best gun be relegated to the waste heap.

It is in the attempt to make something of really superior quality that material is spoiled and workmanship wasted. To produce a best gun, not only must a staff of skilled workmen be obtained, and every man must not only be able, but inclined to do his best, both with respect to his own work upon the weapon, and with due regard to the work of those who have taken, or are about to take, a part in the production of that gun.

The best gun must be tried in various stages, and must pass in each before proceeding to a succeeding stage; hence time as well as money is needful to its production. The well-finished gun is one in which the design is good and carefully executed, every portion being exactly shaped, rightly placed, and perfectly adjusted, with that accuracy of detail which skill and practice alone can give. Finish consists of the due relation of each part to the whole, and is a thing apart from the ornamentation or embellishment of the weapon.

A gun made and finished in the best manner will stand more hard wear than an ordinary gun, even if the principle upon which the commoner gun is constructed be superior to that of the best

gun. Common guns always give way first in small details : a pin works loose or breaks, and as soon as it is replaced, and the gun is made good in one place, it gives way in another, whereas a best gun is practically indestructible, and, barring accident, will last a life time. If, therefore, you purchase a gun in order to enjoy sport have a best gun ; if you must shoot, and do not mind when, take an ordinary gun ; it may fail you when you have a first-rate chance to bag game, but the best gun is always good alike, and thirty seasons' hard wear will leave it as good as new for all practical purposes.

Between the cheapest gun and the most expensive there are weapons which serve the needs of a very large number of sportsmen. Those guns which are sold at the lowest prices, and are actually the best value for money, are the weapons of a good type which are out of fashion. Guns with double-grip action, with side-lever action, with under-lever snap action, with non-rebounding locks, with hammers of large size and standing high, have much depreciated in market value ; from £5 to £10 is sufficient to give for such a gun, unless it is by a maker of very high standing, when, even as a second-hand gun, it may realise £25. Good serviceable hammer guns with a sound top connection, fine barrels, and of honest workmanship throughout, may be purchased new from about 12 to 13 guineas. And hammerless guns, upon a principle

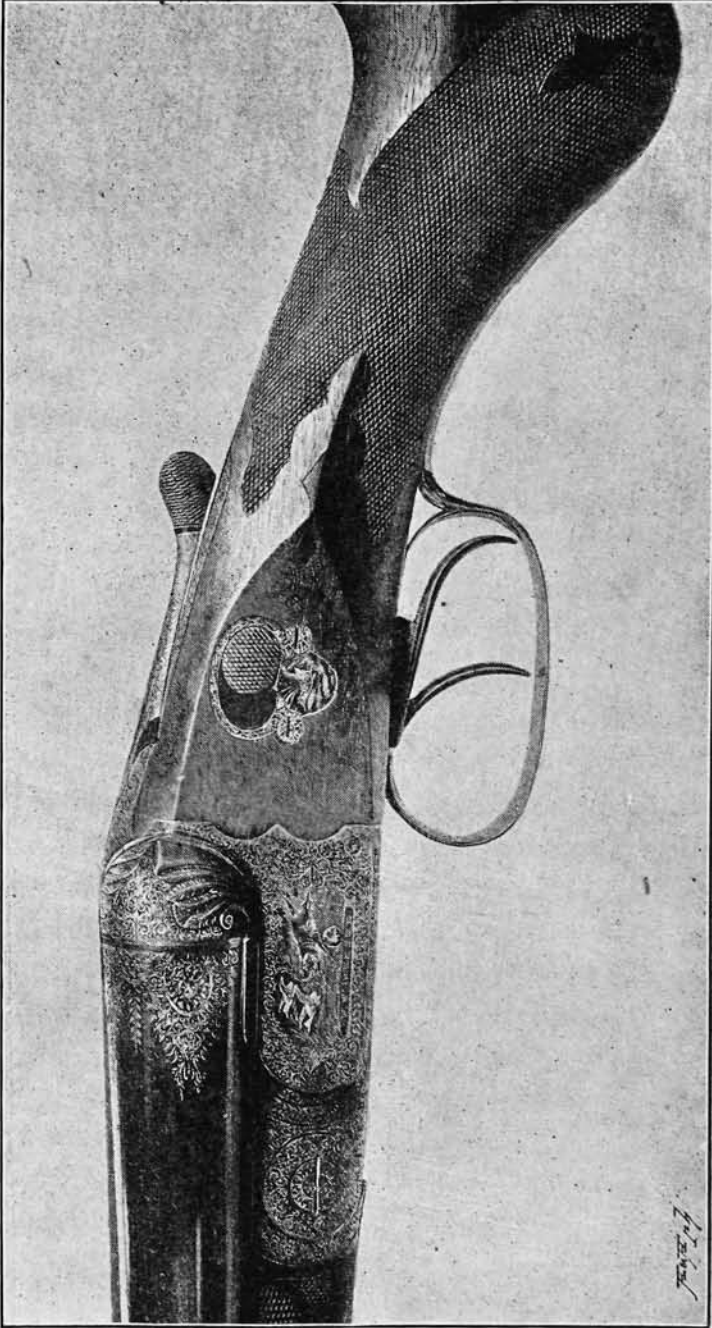

FAC-SIMILE OF ONE OF W. W. GREENER'S EJECTOR GUNS.

which every practical sportsman and expert will endorse as being good, may be purchased at about 15 or 16 guineas. There are writers and advocates who will contend that this price is too low for a reliable hammerless weapon, but such writers judge from prices asked in the most expensive shops, and are not acquainted with prices current at the centre of production. It is generally admitted that guns are made in Birmingham of quality equal to those produced in any other town in the world, also that they can be produced more cheaply there than in any other town in Great Britain. *Verbum sap.*

The high prices obtained for Birmingham guns the last few years go to show how highly they are esteemed by sportsmen. Twenty years ago 35 guineas was considered a very high price for a Birmingham gun, now the modern breech-loader of two or three makers sells at 45 guineas, complete, whilst the author's Royal Gun realises 60 guineas without a case.

The author trusts that he has made clear to his readers the necessity for close investigation of workmanship before purchasing. In general appearance a cheap untrustworthy gun may closely resemble one of good quality. It is the practice of some manufacturers to make the outward appearance of their weapons exhibit some fine, if not careful, workmanship, and a few shillings spent upon polishing, hardening, chequering, engraving, etc., will make a badly-fitted gun look the same as a

fine gun to the eye of the average buyer—even to be preferred to one of much superior quality, in which the money has been expended in the fitting of action work, lock mechanism, barrel boring, etc., etc., all of which are essential to the gun, and really determine its worth.

Very fine workmanship, elaborate finish, and the best of material, is a combination always costly. Good material, sound workmanship, and careful finish are more easily obtainable, and these points should be required in the cheapest weapon. Inferior workmanship, indifferent material, and “elaborate” finish cost less, and are more often found, as makers hope, by imitating the well-designed and executed patterns of the best makers, to convince purchasers that the copies are of equal quality. For instance, the polish and gloss *outside* a pair of barrels is of small importance, yet a few shillings saved in the boring and shooting, and half of the money so saved expended on the polish and bronzing of the barrels will “fetch” more buyers than a gun in which all the money has been spent upon essential points.

An expert will tell whether a gun action is well fitted or not—whether the locks are well filed, or badly made. The average sportsman cannot, hence gun-makers tempt buyers by appealing to the eye, instead of expending money where the result cannot be seen, but is found by experience. Some London makers and others have followed the author’s plan of producing guns quite plain, almost

musket-like in their outward appearance, and the money usually expended upon polishing, engraving, chequering, and otherwise embellishing the weapon, spent where it is absolutely required. The result is a sound, serviceable gun, at a low price, and bearing a name which is sufficient guarantee of its reliable quality. If the gun cost quite as much, and various prices were cut down, and others increased, so that a prettier gun might result, the manufacturer of good reputation would not care for it to bear his name. A cheap gun of flashy appearance should be avoided. A pair of good straight barrels, well-fitted breech-action, and reliable locks, may not show to advantage by the side of a pretty stock, glistening barrels, and artistic engraving, but in the field are worth very much more.

GUNS WITH EXTRA BARRELS.

When a gun is required with two pairs of barrels, of the same calibre, for one stock, one pair full-choke, and one cylinder, the latter cannot be made more than 4oz. lighter than the choke pair.

Gun-makers are sometimes instructed to make guns having a pair of 10-bore and a pair of 12-bore barrels for the same action. This plan cannot be recommended, as the weight and balance of the gun has to be sacrificed to one pair or the other, if not to both. The action must be large enough for the 10-bore, therefore the 12-bore barrels must be very thick at the breech ends.

It is better to have two guns than such a weapon as indicated.

The weight of the gun with 12-bore barrels cannot be made much lighter than with the 10-bore barrels, as sometimes supposed. A pound difference is quite impossible if the weapon is to be satisfactory with either pair of barrels.

The cost of fitting new barrels to old guns is usually about half the original price of the gun, for fine guns, but no barrels can be fitted properly for less than ten guineas, as much hand-work is required, and that of the best skilled gun-smiths.

CHAPTER III.

OF THE SHAPE AND DIMENSIONS OF GUN-STOCKS.

THERE is no definite authority for the prevailing fashion in gun-stocks, and the dimensions and shape of this part of the gun have given rise to more frequent discussion amongst gun-makers and sportsmen than anything else connected with shooting.

The measures of the gun-stock include the bend, length, and cast-off. These are of great importance to the user of the gun, and must suit his particular method of handling the gun, as well as the stock being of such dimensions as the shooter's build, *i.e.*, length of arm, breadth of chest, etc., may determine.

The measures of the gun-stock may be ascertained as follows :—

Take a piece of wood or iron, with a perfectly straight edge, sufficiently long to reach from the sight on the muzzle to the extremity of the butt ; lay this straight-edge along the rib, and measure the distance from A to HEEL, and from B to COMB. This is the BEND. The LENGTHS required will be from the centre of the fore or right-hand trigger to

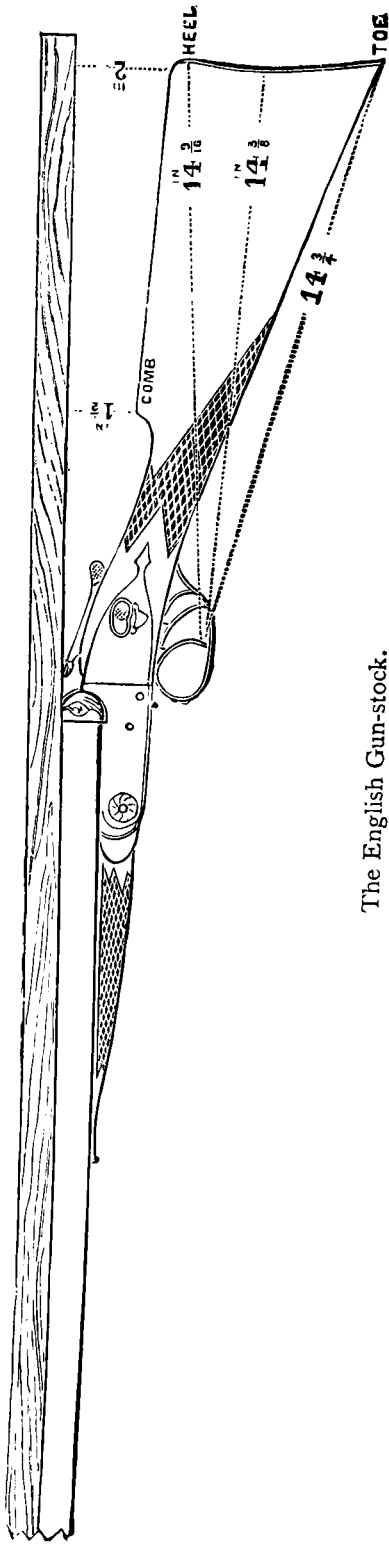

The English Gun-stock.

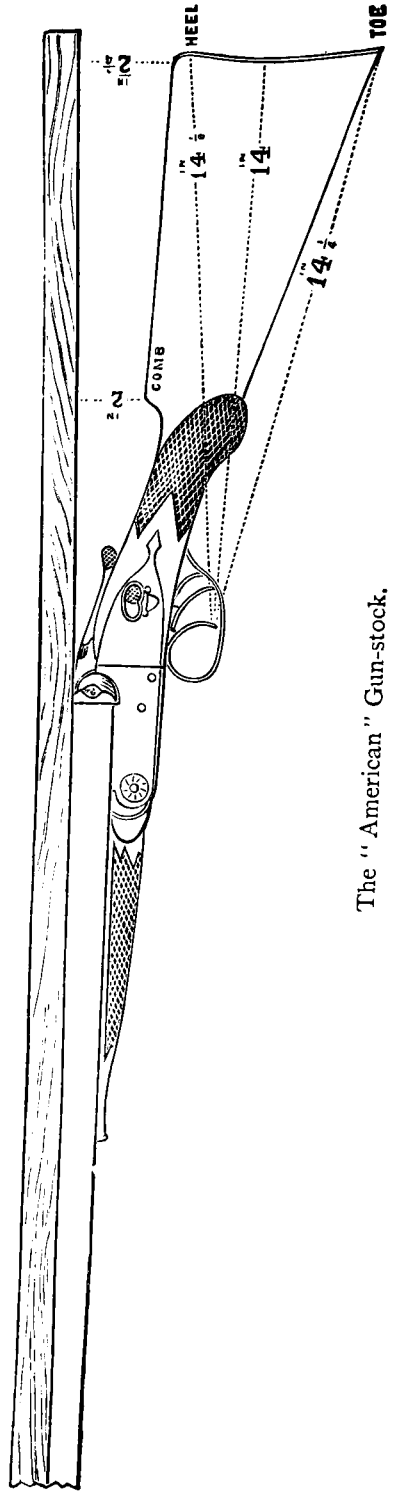

The "American" Gun-stock.

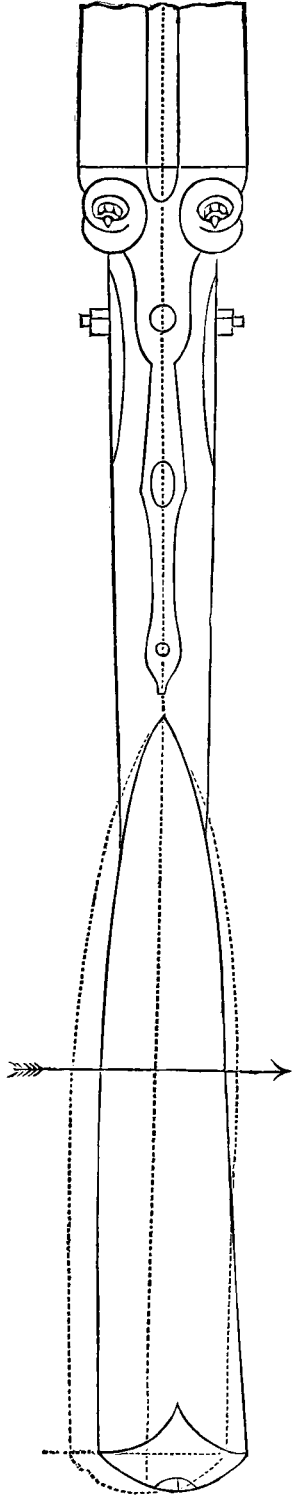

Gun-Stock showing "Cast-off."

the HEEL, CENTRE, and TOE respectively, and the depth from the heel to the toe. The circumference of the hand may be obtained by passing a string round it *immediately* behind the trigger-guard, measuring the string. In taking the length, measure

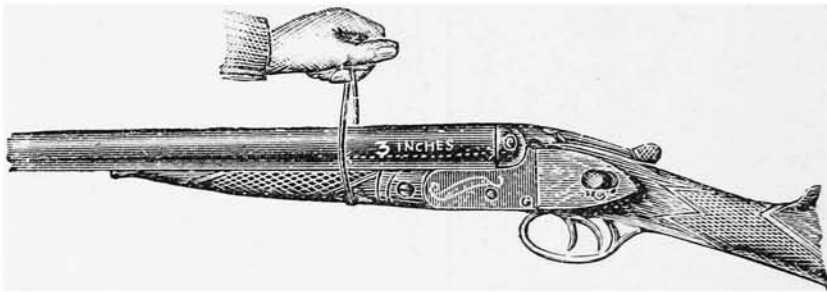

Showing how to Balance a Gun.

the extreme length, and not to the edge of the heel-plate. The dimensions given above are in due proportion, and as usually made for English and American sportsmen respectively.

CAST-OFF is the amount the stock is thrown out of truth with the barrels in a *lateral* direction. Most gun-stocks are twisted over—that is, the toe of the butt is more “cast-off” than the heel—the usual “cast-off” is $\frac{3}{16}$ ths for heel, and $\frac{3}{8}$ ths for toe. The object of “cast off” is to admit of a proper aim being easily taken, and the amount will vary according to the build and physique of the person for whom the gun is constructed.

Balance.—This is always to be measured from

the breech-ends of the barrels. It is best to balance the gun on thin string.

A 12-bore with 30-in. barrels weighing 7lbs. or over should balance at about 3ins. from the breech ; if with 27-in. or 28-in. barrels and $5\frac{3}{4}$ lbs. to 6lbs., about $2\frac{5}{8}$ ins. from the breech would be considered a good balance.

The measures given in the illustration of the English gun-stock are the dimensions usually adhered to by gun-makers in this country, and guns so built are found to suit quite 80 per cent. of British sportsmen.

Americans use guns with stocks much more crooked, as, when shooting, they keep the head erect, and many English colonists follow this rule, the crooked gun-stock being quite common in South Africa.

The lengths of the gun-stock from fore-trigger to toe and heel will regulate the angle of the butt, and the *cast-off* will throw the butt over a little, so that unless the butt were rounded or champfered, its *edge* only would touch against the shoulder. The amount of champfer required will depend upon the amount of "cast-off," and the build of the person for whom the gun is intended. Dr. W. F. Carver always shoots with a heel-plate, not only much hollowed—*i.e.*, *very much* shorter to centre than to the extremities—but also champfered so as to fit squarely against the muscles of his shoulder. Many shooters will find it more comfortable to



Gun-Stock with Chamfered Butt.

shoot with a gun having the butt so rounded, or sloped, than with the usual butt, which is of equal length to either edge.

Guns with stocks from 14in. to 14 $\frac{3}{8}$ in. long, measured from the fore-trigger to the centre of heel-plate, will be found in most gun-makers' stock, and the common "cast-off" is $\frac{3}{16}$ in. at heel, and $\frac{3}{8}$ in. at toe. A sportsman, above the average height, should take a gun-stock longer than usual, and also one slightly more bent. The longest stock the author has made is 15 $\frac{3}{4}$ in., and the greatest bend 4 $\frac{1}{4}$ in. It rarely happens that stocks shorter than 13 $\frac{3}{4}$ in. are required. A shooter with sloping shoulders will find that a stock about 2 $\frac{3}{4}$ in. bend at heel and 1 $\frac{3}{8}$ in. at comb, will probably suit him best.

The gun-stock must be so fashioned that the butt shall be at a right angle, or nearly so, to the barrels, and the gun will stand with the barrels *almost* perpendicular. Some, however, prefer that the gun when stood upright shall be such that the sight and the centre of the butt shall be in a plumb-line.

The "cast-off," as already explained, is the *lateral* deviation of the stock from the common axis of the barrels. This permits of the barrels being more readily aligned.

A thin man requiring but little cast-off to his gun, whilst a stout man with broad shoulders may need a gun much cast off.



Shooting a Straight Stock Gun.

EXPLANATION.—At the time of firing the whole of the butt-plate should be in contact with the shoulder of the shooter. When firing at ground game this is almost impossible with a straight gun stock having the usual amount of toe. Usually the gun stock projects much above the shooter's shoulder—as shown—the result being that the recoil causes the gun to jump up. If the gun be fired whilst held as shown above, the cheek of the shooter would have to sustain a goodly share of the force of the recoil.



Shooting with a Rational Stock.

EXPLANATION.—The rational stock is, at the time of firing, squarely bedded against the shoulder of the shooter, and whether firing at ground game or at birds flying straight over, must always have a greater portion of its butt-plate in contact with the shoulder of the shooter than it is possible to get when using the ordinary straight stock.

The pistol hand gun-stock, especially in that form shown in the illustration of the American gun-stock and known technically as half pistol-hand, is the common form throughout Canada and the United States, and is also being adopted by the sportsmen of Australia and South Africa.

Amongst English sportsmen the use of the pistol grip is confined chiefly to double rifles and large bore guns, and it permits of a firmer grip than the straight hand stock, but is not so convenient for pulling the left trigger in quick succession to the right. With the straight grip the hand may slide backwards, but with the pistol grip it is necessary to bend the trigger finger more to fire the second barrel rapidly. Some sportsmen, whether using straight or pistol hand stocks, find it more convenient to pull the near trigger first and move the hand forward to fire a rapid second.

There are other shapes of gun stocks, with some of which sportsmen may be acquainted, but to others they will be novel and offer certain advantages.

First, there is the *horn guard*, equivalent to the *scroll guard* of the old-fashioned English rifle. This guard is supposed to allow a better and firmer grip of the gun to be obtained with the right hand—the same advantage as claimed for the *pistol hand* stock, which, moreover, prevents the fourth finger of the right hand from being bruised by the back of the trigger-guard.

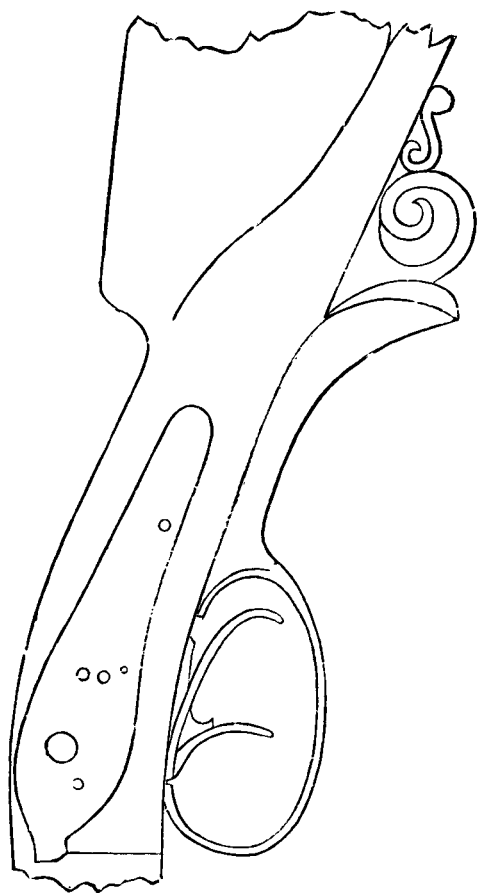

The German Horn Grip Guard.

The horn guard is much used by some Continental sportsmen, and the German gun-makers particularly fashion it into an ornamental fitting for either the shot gun or rifle.

Another Continental form is the shield guard, or horn before guard. With this style of stock the gun is grasped just in front of the trigger guard by the thumb and forefinger of the left hand, the palm of the left hand and the remaining fingers being firmly pressed against the guard. This style of holding the gun is not to be commended, but it must be admitted that many fine shots are to be found who never hold their gun differently.

The rational gun stock was introduced by the author some time ago, and it embodies qualities long sought in pistol grip guns, and the undeniable advantage of the straight stock.

In this stock, as will be seen from the illustration, there is more than the usual bend at the *bump* or *heel*, and that the comb is not straight, but *arched* slightly ; and as the cheek touches the stock about midway between the *heel* and the *thumb*, it is there, and there only, that the stock need be straight.

With the usual English gun stock, put up in the usual manner, it will be found that about *one-third* of the upper part of the *butt* projects above, and has *no* bearing against the shoulder. This leaves the sharp narrow toe to steady the gun and to take the recoil.

With the rational stock the face of the shooter

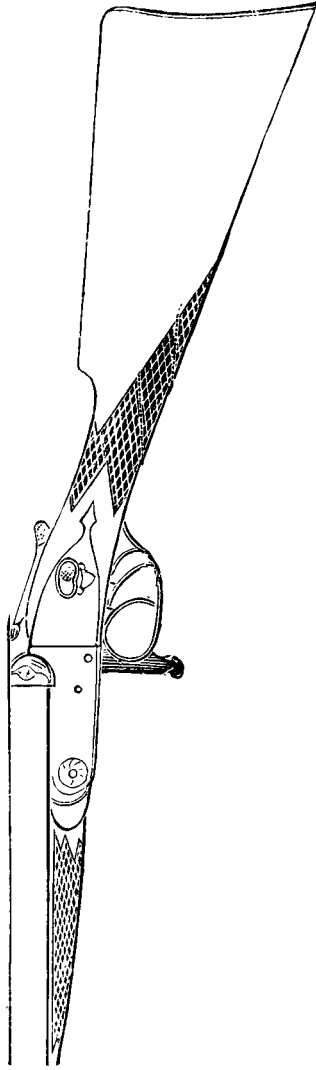

The Horn before Guard Gun-Stock.

will be resting upon the stock when the *bump* or *heel* has reached a level of the shoulder, and the whole of the *butt* will find a bearing in the hollow of the shooter's shoulder.

The bend of the gun will, with the "rational" stock, be about $2\frac{1}{2}$ ins. at *heel*, $1\frac{1}{2}$ at *comb*, and $1\frac{5}{8}$ midway between heel and comb.

In the rational stock the wood is left *thicker* at the toe, and thinner than usual at the heel. This enables the shooter more easily to get his gun into proper position; with the large heel and thick comb the stock often catches against the shoulder, and *jumps* afterwards to the position from which it is fired. It is believed that by reversing the taper of the butt the gun will *invariably* be brought with greater certainty and speed to its proper bearing at the shoulder.

The rational gun stock also, instead of being straight from trigger bow to toe, is arched slightly near the end of the grip. This *shaping* of the stock is a very modified form of pistol grip, and allows not only of a firmer and easier grip being taken, but also permits the elbow to fall lower and to a more natural position when the gun is at the shoulder and about to be fired.

Of gun stocks built for special purposes the most common is that for use from the right shoulder, but to be aimed with the left eye. This form of gun stock shows in an exaggerated form the utility of cast-off. The stock is bent over not until

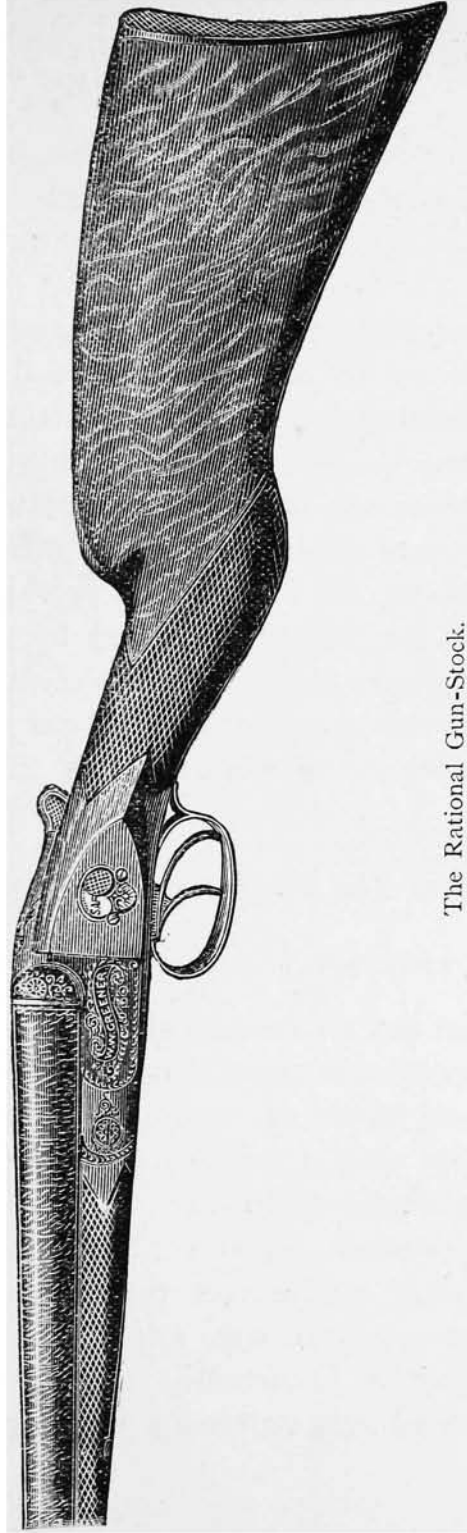

The Rational Gun-Stock.

the rib is convenient for the right eye, but until it is in a position to be readily aligned by the left eye when the gun is brought up to the right shoulder.

The author when treating of the handling of the gun and the art of wing shooting will point out exactly of what value a correctly-fitting stock is to the shooter.

Many sportsmen and some gun-makers are inclined to overrate the importance of the fit of the gun, even going so far as to say that one's shooting may be greatly improved by having an exactly-fitting gun stock. In this connection the experience of many sportsmen will bear out that of "F.," who wrote to the *Field* of April 9th, 1892, as follows :—

Extract from *The Field*, April 9th, 1892.

SHOOTING UNAMENDED.

Sir,—I am but an average shot. After reading much correspondence concerning the utility of try guns, and their power of improving a man's shooting twenty per cent., I went to a well-known gun-maker to see what I could do.

After a certain amount of shooting which seemed to point to the fact that I shot high to the left, the try gun was altered, and with it properly adjusted I certainly seemed most successful. I accordingly ordered a gun to pattern, the

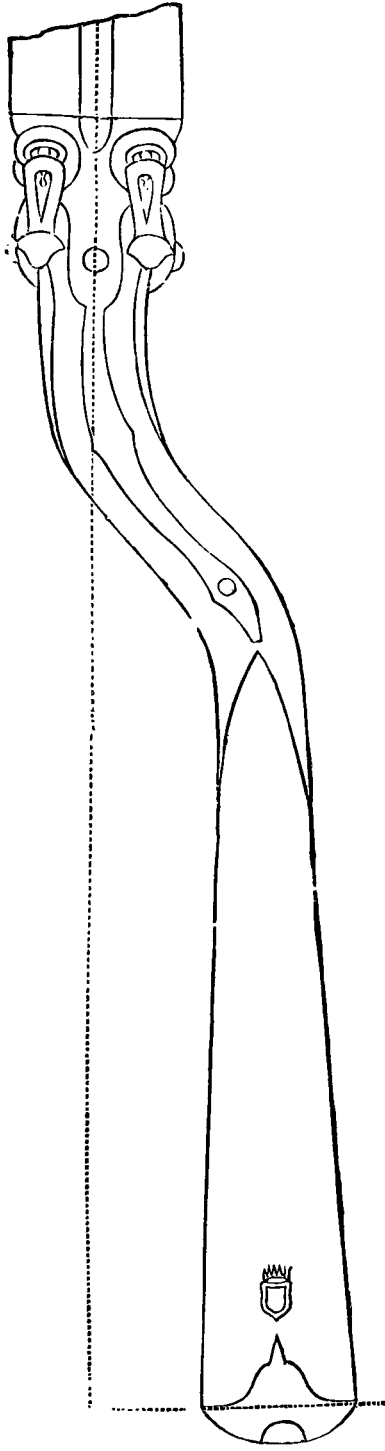

Bent Stock for use from right Shoulder with the left Eye.

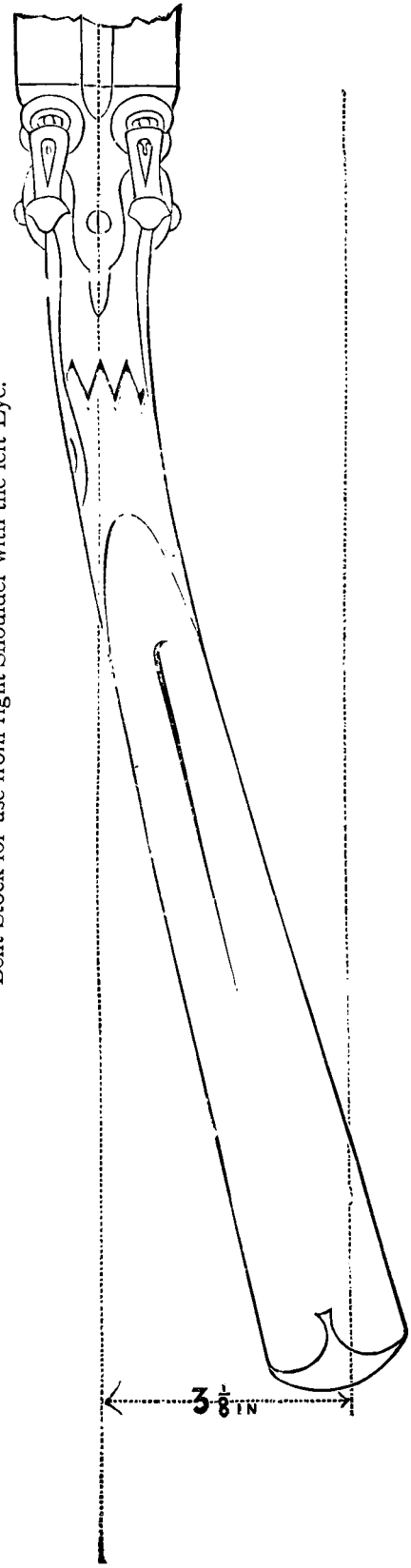

Stock cast over for left Eye.

gun-maker saying I ought to be a good shot, as I shot so regularly in the same place, and it was only that my gun did not suit me.

I have now been shooting a great deal, but I find to my astonishment that it makes not the slightest difference which gun I have in my hands. One (the new one) has a fair bend and much cast-off; the other (my old gun) is very straight with no cast-off.

The only thing noticeable is that after a change of guns the gun seems to come up awkwardly the first shot or two. But now if I change my gun, before beginning to shoot, I put the gun to my shoulder a few times, I find that my left hand goes a bit farther forward on the bent gun, and that I am inclined to move my head a little to the right with the gun without cast-off, which I take it is the natural consequence of the difference of make.

But if I take the precaution to put the gun to my shoulder a half-dozen times or so before shooting, what gun I have in my hand signifies nothing.

I offer these remarks on the utility of fitting a gun, in case any of your correspondents might wish to comment on the fact of my experience. I should much like to find a gun which would really improve my shooting.

At present I am far from gun-makers. I am afraid I feel convinced that a good eye alone can

make a good shot, and provided the gun is of good make and pattern, fitting is of little or no importance.

Central India.

F.

OF THE FIT OF GUNS.

The fit of a gun is a truly personal matter, for although the majority of sportsmen can shoot well with the gun which suits eighty men out of every hundred, unless the gun is liked by them they will never feel that they shoot so well with it as they should, as no two persons are alike; therefore every person to be exactly suited with a gun will require something different to that which will suit another, but in practice the difference is often so slight as not to be noticeable. The most important point is the weight of the weapon, for many sportsmen sadly overweight themselves with needlessly heavy weapons; the gun when put up at a mark for trial does not seem heavy, but after carrying it for a few hours or when fatigued by walking, waiting, or working, the gun will not be "put up" as it was when the sportsman was fresh. The lighter the gun the greater control the muscles have over the gun to align it properly, and the longer they retain that power. The ability to handle a gun with precision is more likely to fill the game-bag than the possession of a perfectly fitting weapon. The really good shot can shoot well with almost any gun; a perfectly fitting stock

will never make a good shot out of a bad one. There is no reason, however, why the sportsman should use a gun that does not suit him, nor need it be advanced that because Mr. E. D. Fulford, who grassed 194 pigeons consecutively, Dr. Carver, Captain Brewer, Mr. J. Elliot, and other world-renowned shots, were never "measured" for a gun, other sportsmen may not avail themselves of the best methods for getting a gun that will suit them.

Most men align a gun with the right eye, that eye usually being the stronger. If the sight of the left eye is stronger than that of the right, the shooter must close his left eye when aiming, shoot from the left shoulder, or have a gun so made that it is alignable with the left eye. To ascertain which eye is the stronger, take a finger ring and hold it out at arm's length, look through it with both eyes open at some object twenty or more feet distant; close the left eye; if the right eye still sees the object through the ring, which has not been moved, the right eye is the stronger, and may be trusted to align the gun, and the sportsman may with advantage dispense with shooting correctors, two-eyed sights, *et id genus omne*, and keep both eyes open in shooting.

TO CHOOSE A GUN THAT WILL FIT CORRECTLY.

Take a gun and put it up to the shoulder two or three times without aiming at anything in particular; if it seems to come up easily and be under

perfect control, look at a mark ten or twenty feet distant and slightly higher than the shooter's shoulder, fling up the gun quickly whilst looking steadily at the mark, and immediately the gun is at the shoulder, close the left eye, and glance at once along the rib, the sight on the muzzle should cover the object at which the shooter was looking as he brought up the gun. If, upon this manœuvre being repeated several times, it is found that the gun each time covers the mark at which it is aimed, it should be tried in like manner at other marks, at different distances and elevations ; if these marks are covered in the same manner, the gun may be considered a fit, and a little practice will make the shooter quite at home with the weapon ; it should then be tried at a target, take a few snap shots at a bull's eye, and if the shots are not placed central, something is wrong with either the gun or the shooter. If a man cannot hit a fixed mark at thirty to forty yards every time with a shot gun, he cannot expect to hit birds on the wing.

The sportsman who can make his choice out of a large stock of guns or with the assistance of an experienced man to guide him, has a great advantage over the man whose trials must be made with a few weapons and without the help of an expert to correct any faulty actions which may escape the observation of the shooter. For instance, a person adept in the art of gun fitting would detect at once

whether a second aim was taken in aligning the gun, and could immediately so alter a dummy try gun as to come up in the way desired ; whereas the shooter, if alone, must note where the gun points, and calculate what amount of alteration is necessary. If a gun is pointed much below the mark at which it is aimed, the stock of the gun is too crooked, too short, or the gun too heavy.

If it points above the mark at which it is aimed, it is too straight or has too much toe upon the stock. It is much better to use a gun that is too straight than one that is the reverse, as we shall try to prove in our chapter on the use of guns.

If it points to the right, it is cast-off too much ; if to the left, the cast-off is not sufficient. If it is not horizontal, but twisted over so that the left barrel is the higher, the stock requires to be twisted over by casting off the toe more ; if the right barrel is higher, which is very rarely the case, both the cast-off of the gun and the shape of the butt must be altered.

The straighter and longer the stock which can be manipulated with ease, the better and quicker will be the shooting, and less fatiguing the work of a heavy day's shooting. All good guns are so regulated that, aimed point-blank and dead-level along the rib, they will centre on the mark at forty yards' distance.

Some trap shots require their guns to carry as many as 6in. high at forty yards ; this is preferable

to using a gun which shoots high because, being too straight in the stock, it is aimed too high. Misses with a shot-gun, as with a rifle, more frequently arise from errors in elevation than the misdirection of the aim.

The hand or the grip of the gun must not be so thick that it cannot be grasped with ease ; it may be of oval section, or egg shape, with the smallest point at top, or, to afford a better grasp, even diamond shape in section : it must not be round, or have too fine or too flat a chequering, or feel clumsy, and the fore-end must be narrow, standing high from the barrels, and fall full into the palm of the left hand, gripping the barrels.

A short gun-stock assists the shooter to get up the gun freely, but is against his holding it firmly against the shoulder ; a large butt, not too flat, and with a fairly broad toe, is the best for bedding firmly against the shoulder ; it should, in most cases, be slightly shorter to the left edge of the butt-plate than to the right. The better and more truly the butt fits the shoulder the more comfortable will be the gun in use, and the less appreciable will be the recoil.

The "try gun" is a gun-maker's tool, which permits of the stock being altered to any length, bend, cast-off, and shape of the butt, and is of use in fitting a sportsman who needs a gun of special build. Most of these guns are capable of being fired, but, as not one of them handles at all like

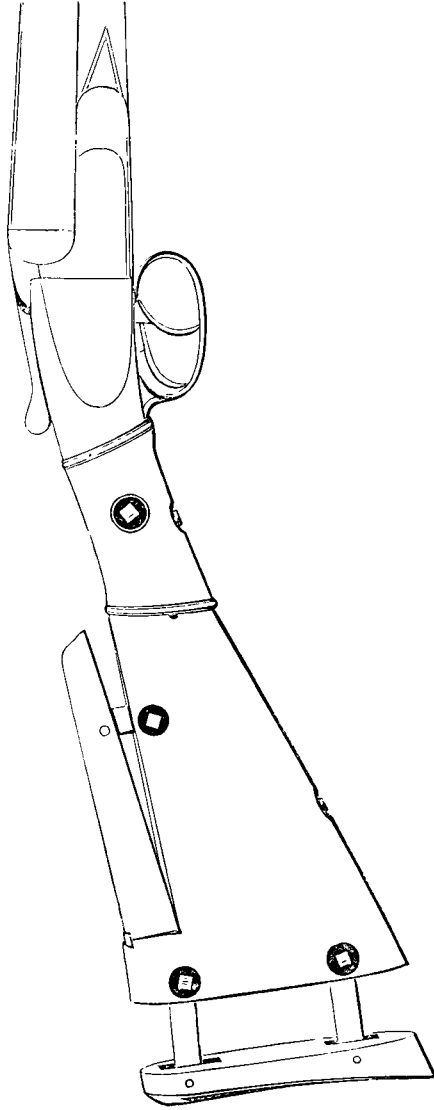

The Adjustable Try Gun.

an ordinary gun, it does not follow that, because a shooter is able to use it with success, a proper gun made with the same measurements of stock will prove quite suitable. It is a gun-makers' tool only, and can be used to good advantage only when in the hands of an experienced gun-fitter.

OLIVER'S SIGHT-ALIGNER AND ADJUSTABLE
GUN.

The sight-aligner and adjustable gun, invented in 1882 by Mr. E. Oliver (Mr. W. W. Greener's London House manager), is so contrived that an expert stands behind the sight disc, and while the aim is being taken he can discover whether both eyes of the shooter are open, and if the aim is a correct one. It is possible for him to see right down the barrels, providing there is a good light. This was used with the first try gun made, and was adopted by many gun-makers to get their customers properly fitted with guns.

It is sometimes said that a sportsman cannot shoot with a gun that suits him if he varies his clothing; possibly some men cannot, but they are not good shots, nor should they pose as such, for, as before stated, the good shot, the man who knows how to handle a gun and how to aim, will shoot well with any gun. Dr. Carver has in a single exhibition shoot of less than an hour's duration shot and performed equally well with a Winchester repeating rifle of the military model, a double shot-gun



Oliver's Sight-Aligner and Adjustable Gun.

of 2 $\frac{3}{4}$ in. bend, and a double shot-gun of 2in. bend. The man who really means to shoot well does so irrespective of any trifling wrong dimension in the weapon he has to use, and the acquisition of the art of shooting enables one to do what the hyper-critical Piccadilly sportsman would not attempt under the most favourable conditions.

SHOOTING POSITIONS.

Of the many shapes of gun-stocks, the sportsman will have to determine which is the one best adapted to his style of shooting.

A manufacturer has a collection of photographs of the members of a first-rate gun-club, taken as they face the trap and have given the word "*pull.*" Of these crack shots there are not two who hold the gun exactly alike ; each shooter, in some measure, adapts himself to the gun which he prefers.

In the illustration of the Continental style of shooting, it will be noticed the gun is nearly at right angles with the chest of the shooter, and the left hand grasps the gun immediately in front of the trigger-guard. A man holding the gun in this fashion could do with a stock 1 $\frac{1}{2}$ in. longer than when shooting in Captain Brewer's style, which is just the other extreme, the left hand is as far forward as it is possible to get it. Much importance is to be attached to where the gun is grasped by the left hand.

Another style of shooting is to hold the gun



Captain Brewer's position at the Trap.



Continental Style of Shooting.

across the chest, as in the illustration showing the use of the "Rational Stock."

Some men who attend second-rate pigeon shoots and do not take their own guns, but rely upon borrowing one when they arrive at the grounds, are able, by putting up the gun a time or two, to adapt themselves to the measurements of the gun. Should it be too long in the stock, they hold it well back with the left hand; if too short, they slide the hand forward until they find it comes up comfortably. When too crooked, by placing the hand farther forward it makes the stock appear straighter.

When ordering a gun, to do so personally is, of course, the best, but should it be impossible to do so, a photograph would be a great assistance to the gun-maker, as it would enable him to form an idea of the man for whom the gun is to be made. If the sportsman possesses an old gun which suits him perfectly, the gun-maker should have it, in order to copy it exactly in measurements, etc. At the author's works in Birmingham, try guns and every modern appliance are used for fitting guns, and there is always a large stock of guns of different measurements on hand, so that invariably a gun may be selected which will suit, and the shooting performance tried on the shooting range which is on the premises, the advantage of this being that the choking can be modified to the shooting required by the purchaser, and he knows exactly how the gun will perform.

CHAPTER IV.

HANDLING THE GUN—HOW TO PUT IT TOGETHER—HOW TO CLEAN IT, AND KEEP IN GOOD ORDER—HOW TO PREVENT BREAKAGE AND DAMAGE—HOW AND WHEN TO SEND FOR REPAIRS—TEMPORARY BREAKDOWNS AND THE REMEDY—ROUGH-AND-READY REPAIRS.

THE purchaser of a new breech-loader should receive instructions from the seller as to the manner in which the gun is to be put together.

Putting the barrels on to the stock is a very easy matter to one used to it; to the sportsman it is not always a simple matter, especially if the gun be of a type new to him. The gun will generally be delivered with the barrels and stock apart. The fore-part will be upon the barrels, probably held there by the snap-bolt, which must be raised or pressed, and the fore-end at the same time lifted away from the barrels. In cheap guns it sometimes happens that the fore-part, which is easy enough to remove when the gun is together, fits very tightly upon the barrels when the action is off. It will come away easily if it be pressed in the direction of the barrels and towards the muzzle.

The gun being put together should be wiped

free from dust ; nothing tends more to clog the breech mechanism than dust.

There are two simple ways of putting barrels and stock together. Take the stock in the right hand, keep the lever open with the thumb, partly draw out the extractor in the barrels ; take them in the left hand and hook them into the breech action as shown in the illustration, care being taken to pull the hook well on to the hinge-pin ; when they are down on the bed of the breech-action, let go the action-lever, turn the gun over, and put on the fore-part.

Another way is to take hold of the breech-action firmly with the left hand ; hold the barrels perpendicularly in the right, hook the breech-action on to the barrels, and press it firmly home.

In putting a Greener Ejector Gun together—

First.—Pull extractors in barrel out to their fullest extent, press back the swivel and ejectors as close to the barrel lump as possible.

Second.—Take stock in the right hand, the barrels in the left, keep both in a *horizontal* position, the left side being uppermost.

Third.—Introduce the barrels into the breech-action body, hook first, and pulling hook well down on the hinge, snap the barrels home. No force is requisite.

Fourth.—Put on the fore-end.

The locks must not be snapped off until the barrels are home. The gun cannot be closed

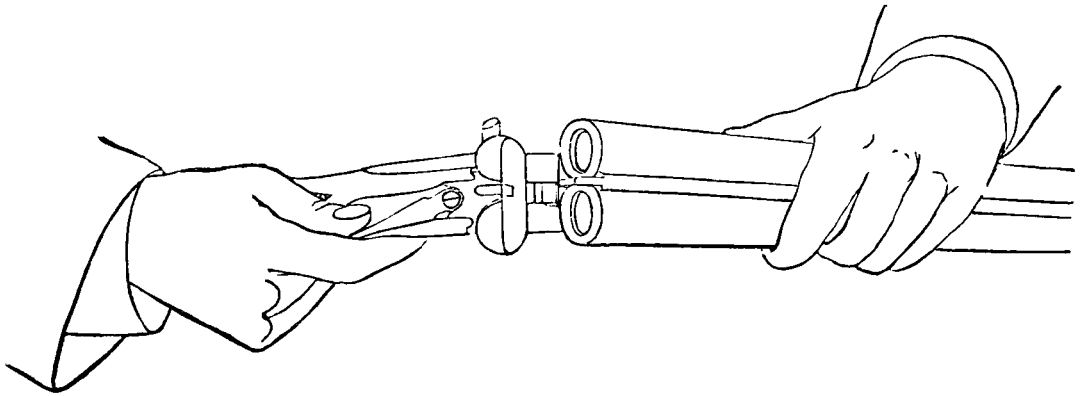
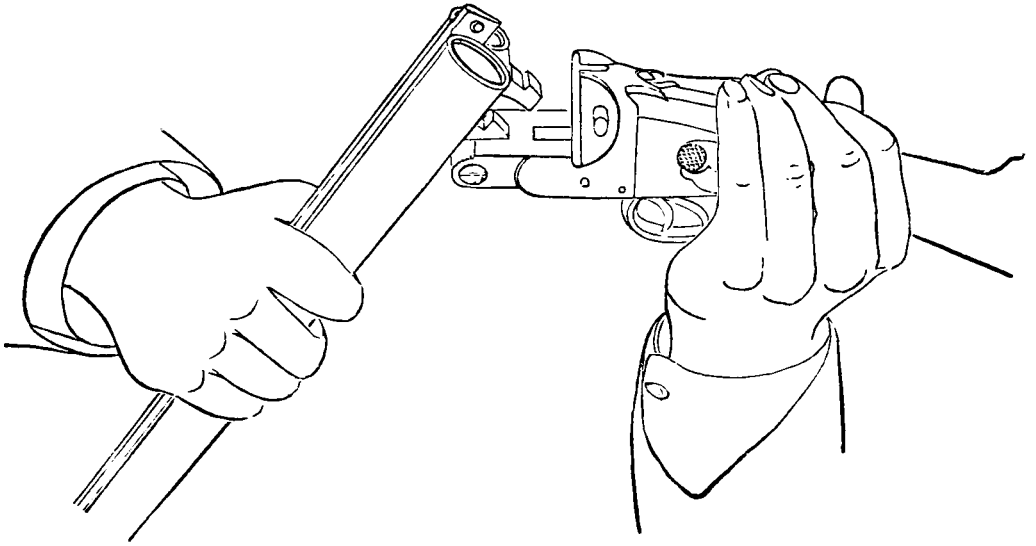

Methods of putting Barrels and Stock together.

unless the locks are cocked. Should there be any difficulty in closing the gun it is proof that the gun is not cocked, and it must therefore be opened still wider before it can be closed ; the barrels are taken off in the usual way. The locks may then be snapped off without injury.

In putting a gun together, providing all the parts are clean, no stiffness will be noticed, and no force requisite. In case of a *deadlock* in putting in the barrel, do not attempt to force the barrels in, but search for the *cause*. Probably, if a hammerless gun, it will require cocking ; if a hammer gun, possibly the strikers are projecting through the face, and do not work freely, so that the extractor drops upon them and prevents the barrels going home.

In cheap guns the extractor often works very stiffly ; this is not so noticeable when a gun is together as it is when one is trying to force out the extractor with the lifter upon the breech-action. If the extractor is rusted in, it will be impossible to force it out with the lifter on the action, and it must be made to work smoothly before the gun is put together.

Having put the gun together, it should be opened and shut several times, and any stiffness or clogginess will at once be noticed. If the gun is a snap-action, the lever should be carried home as the gun is closed. Dirt often finds its way *underneath the extractor*, and this, even in a most

minute quantity, will frequently occasion stiffness in working, or very possibly prevent the gun from closing. Oil and dust, and sometimes a little rust, will be found in the bottom holding-down bolt ; this causes the gun to work stiffly. The gun must *never* be *forced* open, or unusual *force* used to close it. If the gun does not open *freely*, it should be carefully examined, and on the principle that a stitch in time saves nine, it may be cleaned thoroughly, providing the cause of the stiffness is found, and the obstruction removed.

The keeping of the gun clean, and the mechanism free from grit, will ensure immunity from the annoyance of a "jam" in the field. In case of the sticking together of parts that should work freely—such as the strikers jamming in the breech-action, the extractor clogging in the barrels, or bolts or any parts becoming fast with rust—there is nothing so good as an application of petroleum ; repeated applications, and the exercise of patience, will not fail to loosen the "cement," and make even the rustiest pin amenable to the persuasion of a hand turnscrew. Having the gun together, and working freely, it will require to be used carefully. It must not be let fall heavily on its butt plate ; it must not be pushed underneath the seat of the dog-cart or waggonette, and left to take its chance ; it should not be left muzzle-up or muzzle-down against a wall, a gate, or a tree. It should not be used as a crutch, an alpenstock, or crowbar. From

a critical examination of many guns returned to the author, after very little wear, he fancies they must at times be utilised for very different purposes to those for which their makers intended them. To speak more plainly, some guns are abominably abused.

The man who means to use his gun roughly is not likely to benefit by reading any number of directions as to the care of guns ; there are sportsmen who do not wish to spoil their guns who act in such a manner as to injure them, and for them the following hints are intended :—

More breech-loaders get shaky in the action by being worked carelessly than from repeated firing or the use of heavy charges. The barrels of a breech-loader should never be jerked down, nor should they be thrown back into a position with a snap. The proper manner in which to load a gun is to drop the stock under the elbow, and press it firmly against the hip or the body, unfasten the lever with the right hand, and with the left grasping the barrels a few inches in front of the fore-end, lower them easily. Close the gun in a careful manner after putting in the cartridges, bringing the stock up to the barrels.

The best cartridge cases are the cheapest in the long run ; when the shells are of poor quality the gas escapes at the breech end, the breech-action is unduly strained by the firing and rendered foul. Cartridge cases must fit the chamber accurately ;

if a case is too large, bulged by an overtight wad, or swelled by wet, it must not be forced into the chamber. More especially the barrels must not be rested upon a fence at the muzzle, and the leverage thus obtained used to force in tight cartridges. A cartridge case with an unusually thick rim forced into the gun will cause more strain on the breech action than much firing with the proper ammunition. If the gun is a good one, it can be preserved longer if only good ammunition is used.

Guns must be taken care of; they will then last many seasons, and give every satisfaction. When not in use they should be stored in a dry cupboard, either on a rack or in their travelling cases. The gun must not be put away at "full cock"; the tumblers may be lowered by pulling the trigger, and such is better than allowing them to remain at "full-cock"; but if the gun is laid by whilst together, two used cartridge cases, well greased, may be put in the chambers, and the locks snapped off; or the tumblers may be lowered by pulling the triggers whilst the barrels are open, but this cannot be done with guns fitted with automatic trigger-holding safeties, nor with hammerless guns which are not cocked by the dropping of the barrels.

CLEANING GUNS.

To clean a gun after a day's shooting. If the gun be wet, it should be wiped dry *at once*, but the

cleaning of the barrels and breech-action may be left until the sportsman or his servant has time to do it properly.

To clean the barrels. Use the cleaning-rod, with tow and oil, or turpentine. To remove the fouling, put muzzles on the floor, and push the rod down to within an inch of the muzzle and draw up to the chamber, or the rod may be pushed right through the barrels from the breech first time. Do this two or three times, then push right through. Use the bristle brush, or the rod with plenty of flannel; finish with the mop soaked in refined neatsfoot, pure Arctic sperm oil, or vaseline.

Never half-clean the barrels; always wipe them dry and clean before finally oiling, and do not put the mop used for oiling into a foul barrel. To remove the leading from the interior of a gun barrel soak with turpentine, then clean well with a bristle, or even a wire brush, but never on any account use emery.

Always wipe the *bed, face, and joint* of the breech-action with an oily rag or flannel. A little linseed oil may be rubbed over the stock occasionally.

Before putting the gun together ascertain that all the bearing parts are free from dust or grit.

The *joint* may be lubricated with a mixture of half best Russian tallow and half petroleum.

In most hammerless guns, if the *cover plate* underneath the breech-action *body* is taken off, the

locks may be inspected, oiled, and any rust, or clogged oil and dust, removed from the *bent*.

The cocking-lifters of hammerless guns, the holding-down and top bolts, and the triggers, if they have a tendency to clog, may be touched with a knitting needle dipped in petroleum. They must be lubricated, whenever they require it, with chronometer oil, Rangoon oil, or finest neatsfoot.

Do not use a feather for the purpose of putting on any lubricant ; a wire knitting-needle or bodkin is much better.

To remove rust from inside or outside of a barrel, procure a tub, and with a kettle of boiling water well scald the barrels inside and out, wipe perfectly dry with flannel, and then oil. It is as well to do this before putting the gun aside for any length of time.

If the barrels are foul through using inferior powder, and the fouling has become hard and dry, cold water, or hot soapsuds, may be used to cleanse them. Water *boiling hot* kills rust.

Turpentine, often used successfully to clean the residue from gun-barrels, will give great trouble if it gets into the fine-fitting parts of the mechanism of the breech-action and locks, and must therefore be used with care.

Rusty or tight breeches in muzzle-loading barrels may often be turned out, providing the breech-ends of the barrels have been soaked in petroleum. Very obstinate breeches may require

to be well heated, as well as lubricated, before they can be turned out, but usually petroleum will be found a sufficient remedy for incipient rust of the working parts. All the parts of the mechanism may be cleaned with petroleum; it removes clogged vegetable and animal oils well.

STRIPPING GUNS.

Some sportsmen like to take their guns all to pieces and re-arrange the parts. This is not requisite, and does not in any way add to the efficiency of the arm. The gun-maker is the proper person to take apart the locks, or strip the breech-action; if there is not a practical man within easy reach the sportsman must, of course, himself endeavour to effect any repairs, but it is not advisable to interfere with any gun that functions properly, nor to practise upon any gun that works satisfactorily. If practicable, have a good gun examined each summer by its maker or a practical gunsmith.

To take to pieces a breech-loader for cleaning or repairs, first remove the fore-end and barrels; then, with a strong hand turnscrew, turn out the side-pins, and remove the locks and hammers together; next turn out the guard-pins, and remove the bow or guard; another pin will then be seen in the rear end of the trigger-plate; remove this pin (occasionally this "hand-pin" is placed in the reverse way, the head of this pin will

then be found on the top of the grip in the tang of a long break-off). The "furniture-pin" should next be turned out ; this pin fastens the fore-part of the trigger-plate to the body of the breech-action, and is easily distinguished. Next remove the "breech-pin" upon the top of the tang of the break-off ; in top-lever action guns the breech-pin is covered by the lever, which must be held on one side whilst the pin is being turned out. After having removed the furniture-pins, the trigger-plate and triggers may be taken from the stock, after which the breech-action may be removed entire.

To strip breech-actions, if the action is a treble-wedge-fast or ordinary top-lever double-bolt action, the first thing will be to remove the spring. To do this, first partly turn out the lever spring pin (under tang of break-off), and with a pair of pliers or pincers take hold of the spring and slightly grip it, and lift the spring towards the head of the pin. It will then be free from its bearing, and may be removed by completely turning out the spring pin. (This does not apply to spiral springs.) Next proceed to turn out the pin or pins connecting the tumbler with the bottom bolt, and remove the bolt by drawing straight out backwards. Next turn out the lever pin on top of lever, and by means of a small wire punch inserted in the lever pin-hole, knock out the tumbler. The lever may then be removed, and the top bolt, if any, will fall out.

In side-lever guns, first knock out the pivot on which the lever works, then remove spring and bolt. Snap guns with lever under-guard may be stripped in much the same manner, but the spring and lever are fixed to the trigger-plate, and the spring must be removed before knocking out the pivot-pin. Owing to the numerous complicated breech-actions that are made, we are unable to say that the above directions will be sufficient to enable an amateur to strip his gun ; but we trust they will be explicit enough as regarding guns of our own make. There are many breech-actions made that puzzle expert gun-smiths to take apart and repair, and it would be foolish for an amateur to attempt to take them apart if a gun-maker is within reasonable distance.

To strip a gun-lock, first remove the mainspring. This may be accomplished with a pair of lock vices, or a cramp may be made by filing a notch or slot in a narrow strip of $\frac{3}{16}$ iron or steel, the size of the breadth of mainspring when at full cock. Having cocked the lock, slip the cramp up the mainspring until it catches, then release the sear and push down the tumbler. The spring being firmly held in the cramp, it may be unhooked from the swivel and removed from the lock-plate ; then unscrew the bridle-pins, and remove the bridle.

The sear may then be lifted off if the tumbler is not in bent. The sear spring will then be at liberty, and may be removed by turning out the

pin. Now the hammer should be removed ; the tumbler-pin is first turned out, and by means of a wire punch inserted in the hole, the tumbler is knocked away from both hammers and lock-plate. If a hammer fits well, it will be impossible to remove it in any other way without injury either to the hammer or the lock. The spring must not be taken out of the cramp ; it requires no cleaning except at the claw or hook. In putting a lock together, first screw on the scear spring, then the tumbler, then place on the scears and cramp the spring with a pair of pliers or tongs, place the tumbler into half-bent. Then affix the bridle, and screw it to the lock-plate. Take the mainspring, ready cramped, hook on to the swivel in tumbler, place the stud in the hole drilled for it in the lock-plate, raise the tumbler to full bent, squeeze the mainspring down close to the plate, and remove the cramp ; the lock will be ready then for affixing the hammer, which should be knocked on after placing the lock firmly on a solid block to prevent the bridle from breaking. To take apart the lock-work of the Anson and Deeley Hammerless Gun, proceed as follows :—

Having removed the barrels, snap down the hammers or tumblers, remove the cover-plate from bottom of breech-action body ; knock out with a wire punch, from the *right* side, the scear pivot, or the one nearest the stock, and remove the scears ; knock out the dog-pin, or the one nearest the fore-

end joint, and remove the cocking levers; partly screw on the cover-plate, and carefully knock out the centre-pivot or tumbler-pin, remove the cover-plate, and the tumblers and mainsprings will drop out upon the breech-action being reversed. The scear springs lie along the bottom of action, and may be removed after turning out the pins. To put the lock-work together, first place the mainspring in the bend of the tumbler, with the stud of mainspring bearing in its proper slot, and its other extremity bearing against the under side of the nose of the tumbler; the tumbler and spring having been placed in the slot must be forced into position with a cramp, or piece of notched wood; knock in the tumbler-pivot half-way, insert the other tumbler and spring in the same manner, knock the wire pivot right through the lifting dogs, the scears must then be put in, and the whole covered with the cover-plate. The "Greener" Hammerless Guns, which have similar tumblers and scears and mainsprings, may be taken to pieces in the same way, but there are no dogs or lifters to be removed.

In stripping muzzle loaders, first raise to half cock, then remove the locks by turning out the side pin, then lift off the barrels and proceed to remove the furniture, and break off as already directed for breech-loaders.

REPAIRS.

When possible, guns should be sent to the

makers for all repairs, as no one else is interested in making the gun last as long as possible, and at the least cost.

At the end of each shooting season guns should be sent to the gun-maker to be examined, cleaned, and if necessary repaired. Some sportsmen find it advantageous to leave the guns with the gun-maker until the reopening of the season, as he knows they will then be cared for properly, and will be returned in perfect order fit for use.

The most common damage is a dented barrel. A small dent may not be noticed by the sportsman, yet be sufficiently large to affect the shooting qualities of the gun. A bruise or large indentation is a serious damage, and a gun barrel so injured should never be fired until properly repaired or the barrel will bulge at the bruised part.

Repairs to shaky breech actions require careful workmanship; if much worn, new bolts, hinge-pin, etc., may be replaced at little cost, but re-stocking a gun is an expensive matter; alterations to the shape or dimensions of the stock also become expensive, as the gun requires to be "done up," *i.e.*, polished, blued, etc., after setting.

If unable to send to the makers, avoid advertising jobsters who are in the habit of putting their own name on the gun under the pretence of having improved its shooting; also prevent all tampering with the barrels unless you know that the man to whom the gun is intrusted has the necessary tools

and skill to do the work properly. When sending for repairs send the complete gun, not any particular part.

The following are the approximate prices for such repairs as are most frequently required :—

Restocking hammerless guns, £3 to £6 or about one-seventh of the actual cost of the gun. Hammer guns from 21s. for keepers' guns ; to £5.

Taking dents out of barrels, reducing small bulges, and repolishing and browning barrels, 10s. to 35s.

Tightening breech actions from 10s., where new bolts, etc., are not required, to 30s.

Cleaning guns simply, hammer guns, 10s. ; hammerless guns, 15s. to 20s.

Doing up an old gun, cleaning, polishing, and browning barrels, polishing and blueing furniture, colouring breech-action, cleaning, re-chequering and polishing the stock, and renovating stock, lock, and barrels, from 20s. to 70s., according to value and work done.

Other repairs are : re-browning from 10s. Re-boring barrels to remove rust and testing the gun, from 10s. per barrel. Re-boring cylinder barrels to improve shooting, 15s. per barrel. Removing choke, shooting, testing, etc., 12s. 6d. per barrel.

Altering bend of stock, 10s. to 25s. ; altering length of stock, 10s.

New cocks, from 5s. each ; new hammerless tumblers, from 7s. 6d. each ; new mainsprings, from

8s. per pair ; new top-lever or action springs, scear springs, etc., from 2s. 6d. each.

EXTRA LIMBS AND TOOLS.

The following extra parts of a gun should always be taken out when out hunting, or exploring in wild countries :—Extra pair of lock mainsprings, extra hammers or tumblers, pair of extra scears, pair of extra nipples and strikers, extra side-pin, extra action or lever-springs, scear springs, and extra triggers.

The following tools will be found useful :—Set of three turnscrews, mainspring cramp, or lock vice, small pair of pliers, small pincers, notched to grip springs and pins.

HOW TO REPAIR GUNS.

The following hints will be found useful to those who use guns far away from a gun-maker's shop, and need to repair broken-down guns for immediate use :—

The action or top lever-spring may break, but this need not in any way affect the utility or safety of the arm, only the lever will have to be moved home when the gun is closed, instead of it snapping there. The strikers of ordinary guns will become useless after continued wear, owing to the hardened hammer flattening the head of the striker, and so shortening its travel as to make miss-fires of frequent occurrence. The nipple must then be turned out

with a key or a pair of pliers, and a new spare striker inserted. In hammerless guns the tumbler and striker being in one, and the point itself striking against the soft copper-cap of the cartridge, this flattening does not occur, the strikers being of the best mild steel, carefully hardened and tempered, and so well made, that breakages are of very rare occurrence.

To remove a dent, the following is the readiest expedient:—Having removed the barrel from the action or stock, insert in the barrel at the breech-end a solid leaden plug or bullet, as near the size of the barrel as possible. Place the barrels on a solid block with a stout ramrod or stick in the barrel, reaching within a few inches of the chamber. Then proceed to flatten out the plug or bullet by striking it with another rod and a hammer. The bullet being prevented from slipping down the barrel by the ramrod underneath, it will expand until it perfectly fits the barrel. Then proceed to force the plug—having first lubricated it—towards, and gradually past, the bruise; turn the plug half round in the barrel, and repeat the process until the bruise is raised. The barrel should be warmed during the process, by applying a hot iron to the outside of the bruised part. Great care will have to be taken not to get the plug jammed in the barrel. If a taper lead plug can be obtained, the process will be greatly simplified, and a slightly taper iron or brass plug is much better than a soft

lead one. If the barrel is bulged, a similar plug should be made, and great care will have to be taken to hammer the bruise down to the plug with a light hammer. If a hard metal plug can be obtained near the required size, it may be packed with paper until of the required diameter. The plug must be slightly longer than the bruise or dent.

To splice a broken stock, first glue the stock as well as possible, then glue round the fracture a piece of thin leather or canvas, and whilst warm tightly bind with waxed thread or a fine lace; when the whole is dry it will be almost as sound as before. The wood should be warmed before glueing, to enhance the chances of perfect success.

ALTERING GUNS.

Guns cannot be converted from hammer to hammerless upon any good reliable system; they cannot be made self-ejecting on the Needham or Greener principle, and with the exception of converting non-rebounding locks to the rebounding principle, it is doubtful if any conversions pay for the cost.

THE GUN-ROOM.

Guns and shooting paraphernalia should be kept together. If a room cannot be devoted solely to them, a capacious cupboard, or a case fitted with a gun-rack, and several drawers and shelves, will

contain a small battery and the requisite accessories.

Guns are best kept put together, and placed butt down on a gun-rack in a glass case or gun cupboard, but if the case is not practically dust-proof, the guns should be first put in pliable canvas or cloth covers. Guns kept in racks in the open room should always be kept so covered.

Loaded cartridges are best kept on an open shelf, and in a current of air ; boxed up in an airtight cupboard, they will deteriorate more quickly.

After the close of the season, inspect the guns very closely, and send those concerning which there is any doubt to the gun-maker for repairs at once.

On receiving his report, it will be as well to decide quickly as to whether or not new weapons must be purchased for the next season. Some wet summer day overhaul the contents of the gun-room, put the odd cartridges handy for popping at rabbits or vermin, see that the cleaning tools are complete, that the cartridge-bags, game-bags, etc., etc., are in good condition, and make a list of the things which will be required when the season opens.

In the season the gun-room will require frequent attention if it is made use of by more than one person. The cartridges, as soon as they arrive from the gun-makers, should be transferred to the magazine or cartridge-bags of the shooter for

whom they are intended ; a cleaning-rod and gear, turnscrews and extractor put in the travelling gun-case, and the oil bottle refilled.

Useful tools in the gun-room are full length ash or hickory cleaning-rods, and a rod with cotton wool or fine tow kept specially for oiling barrels. It should be a standing rule never to put this oiler into a foul, dusty, rusty, or dirty barrel, but keep it for oiling only.

An oval tundish for cartridge loading, a set of turnscrews, some bristle brushes for cleaning out action slots, etc., small pliers, notched pincers for drawing out tight-fitting pins, a few steel knitting-needles, refined neatsfoot oil, vaseline, petroleum, and turpentine, may be placed near the gun-case for use as required.

CHAPTER V.

THE ESSENTIALS OF A GUN—THE FLIGHT OF A CHARGE OF SHOT—PATTERN—PENETRATION, VELOCITY, STRINGING, SPREAD, RANGE, RECOIL, CHOKES *v.* CYLINDERS—HOW TO LOAD—USEFUL LOADS.

PATTERN.

WHEN a gun is said to make a pattern of 200, it means that 200 is the average number put within a circle 30in. in diameter on the target, the butt of the gun being forty yards—not paces—from the target, the load being 3 drams of black powder, or the equivalent in nitro powder, and $1\frac{1}{8}$ ounces of No. 6 shot, 270 to the ounce (304 pellets to $1\frac{1}{8}$ ounces), which is called the standard load, and originated at the Field Gun Trials of 1875, when the charge of shot was first counted.

It is necessary that the pellets of a charge should be counted into the case if a correct estimate of the gun's shooting is required.

The target should be 3ft. 6in. square, and the bull's-eye marked in the centre. After the gun is fired, to find the pattern, describe a circle around the thickest of the pellets. This can be done by taking a piece of wood with two nails knocked

through 15in. apart, holding one nail in the centre, and marking the target with the other. When shooting at paper targets, substitute a black lead pencil for one of the nails. The best of the pattern is thus obtained, which is called the selected circle. Unless this is done, should the aim be defective, when using a small target, a wrong estimate of the gun's shooting powers may be arrived at.

PENETRATION.

To find the penetration a rack is used, consisting of a wooden frame, so constructed to hold sheets of strawboard about $\frac{1}{4}$ of an inch apart; the sheets measure 6in. by 7in., and weigh 25 to the pound.

The rack is placed about 4ft. from the ground, and fired at from the standard distance (40 yards); the number of sheets pierced by one or more shots is the penetration.

The purposes for which a sporting-gun is required are various. The author has been commanded to build one gun which shall be effectual at all game, from snipe to an elephant; and although this weapon was tolerably successful at everything, it is not to be supposed that it was actually fitted for anything except the elephant. Another customer of the author's, to decide a bet, shot a couple of snipe with a heavy elephant rifle of 8-bore. There is, therefore, no actual limit to

the capabilities of any weapon until trial has been made. The collector who requires humming-birds, and the wild-fowler who thinks of getting wild geese, will arm themselves very differently.

Again, some guns have to be carried throughout a long day's walk ; in other sports the gun is only in the hand the couple of seconds requisite to aim and fire. It is, therefore, evident that what is desired for one sport is of little importance in a gun desired for another sport.

There are certain essentials, however, which should be possessed by all varieties of guns. Amongst the chief of them are:—Facility in loading at the breech, freedom from danger to the user or his companions, simplicity of mechanism, speed in manipulation, handiness, lasting power.

LARGE BORE GUNS.

As stated in the previous chapter, large bore guns are made for wild-fowling, but the subject is too large to be treated here ; the best all-round gun for shore shooting is a double 8-bore of eleven to fifteen pounds weight and full-choked, bored for brass cases ; this gun with No. 1 shot will have sufficient power to kill ducks at 150 yards, but its available range is practically 80 to 100 yards ; at longer distances the pattern is too open, and there is great difficulty in hitting the bird. With $2\frac{1}{2}$ oz. No. 4 shot at 40 yards, the pattern should average

300 and the penetration be equal to 34 sheets of strawboard ; with No. 1 shot, pattern 220, penetration 40 sheets ; at 60 yards the penetration of No. 1 shot 34 sheets, at 80 yards 24 sheets, at 100 yards 16 sheets. The penetration of seven sheets is sufficient to kill a duck.

With paper cases, 5 drams and $2\frac{1}{2}$ oz. of No. 1 shot, has given a pattern of 175 pellets, at 40 yards ; same charge and conditions, but brass cases, the pattern was 225.

For particulars of the shooting powers of other large-bore guns and of their use, sportsmen will not hesitate to procure such books as "The Gun and its Development," the volume "Moor and Marsh," of the Badminton Library, and "Wild-fowling in Ireland," by Sir Ralph Payne Gallwey.

With respect to 10-bores, their use is, as already stated, very circumscribed, and sportsmen may judge of their utility for any particular purpose by comparing the following figures with those given for 12 and smaller bores.

The 10-bore duck-gun full-choked, weighing $8\frac{1}{2}$ lbs. and over, will make a pattern of 250 in a thirty-inch circle at forty yards, with 4 drams of powder and $1\frac{1}{4}$ oz. to $1\frac{3}{8}$ oz. of No. 6 shot.

With $4\frac{1}{4}$ drams, and $1\frac{1}{2}$ ozs. of No. 2 shot, pattern in 30-inch at 40 yards, 160 pellets ; penetration, 25 sheets of strawboard. Same charge, distance, etc., but No. 1 shot, pattern 135, penetration 31 sheets of strawboard. At 60 yards



W. W. Greener's Pigeon-Gun.

No. 4 shot, the pattern should average 65, and penetration be 18 sheets; with No. 1 shot, the pattern 50, the penetration, 26 sheets.

THE PIGEON-GUN.

This is the most powerful variety of the 12-bore gun; it must be so built as to meet the rules of the chief clubs; in England the bore must not be larger than 12, nor the gun heavier than 8lbs.; the charge to be used must not exceed four drams of powder and $1\frac{1}{4}$ ounces of shot. On the Continent and in America 10-bores are allowed, but there is usually some restriction as to charge. The pigeon-gun may be made with hammers or hammerless, preferably the latter. It should *not* have a trigger bolting safety, and an automatic trigger safety for this species of gun is the greatest mistake that can be made.

The shooting required will in some measure depend upon the distance at which the user is generally placed, it being required to have the largest possible killing circle at one yard beyond the trap with the first barrel, and at five yards with the second. In no class of gun is uniformity and regularity of shooting more essential than in the trap-gun. The weight may be from $\frac{1}{2}$ to $\frac{3}{4}$ of a pound greater than in the gun carried for game-shooting, but it is important that the balance be perfect.

An ideal pigeon-gun will balance at about

3 inches from the breech, weigh only $7\frac{1}{2}$ lbs., and fire the full charge of shot ($1\frac{1}{4}$ ounce) with the greatest uniformity; the gun will be hammerless without any safety bolt; it must have a strong breech-action and be fitted with the Greener cross-bolt. The barrels will be chambered for $2\frac{3}{4}$ -inch cases, and in it a charge of 50 grains of Schultze powder may be used without excessive recoil. The gun may have an engine-turned, flat, or half hollow rib. Good shots prefer that the gun should shoot high at forty yards, and that the gun throws the pellets well to the centre. Other shots, standing nearer the traps, do not want extra elevation, and ask for as large a killing circle as can be obtained at 30 yards; with $1\frac{1}{4}$ ounce of shot this is a circle of about 36 inches in diameter, and means a very close shooting gun. An average pattern of 250 in a 30-inch circle at 40 yards is the very best the 12-bore gun will do. For ordinary trap shooting a gun is required to shoot as closely as possible at the trap. The bird must be shot at quickly, and the nearer to the trap it is grassed the better. Naturally, the pigeon-shooter requires as large a killing circle as is compatible with a close pattern. He requires the pattern to be equally spread over the "killing circle," to have the greatest velocity, and the pellets to keep together as much as possible; but of greater importance than all these, it is required that the gun always perform alike. Uniformity in shooting is a quality only found in

the best of guns, and even cylinders, when most carefully bored, will make occasional bad shots, any one of which would allow of the pigeon escaping at twenty-five yards. Therefore, the gun must never shoot wildly, but be always good alike.

In deciding as to the amount of choke required, it must be borne in mind that the pattern made at any given distance does not fairly represent the position of the charge at any given moment. The pellets of the charge issue from the muzzle as compactly as a ball, then, having individual velocities—some go ahead, others lag behind, so that, roughly speaking, there is a distance of twelve feet between the first and last pellet when the bulk of the pellets arrive at forty yards; but of this feature more will be explained later.

FAVOURITE MAKERS OF PIGEON-GUNS.

When reading the reports in the English papers of the events at Hurlingham and the Gun Club, it will be noticed that only a few different makes of gun are used there. These few London gun-makers cater specially for this particular trade by sending their representatives to attend every event, etc., and have thus secured the monopoly, not that their guns shoot any better than guns by other London or provincial makers, nor is it to be assumed that they alone can make good shooting pigeon-guns. This system of advertising would not suit every

gun-maker. The author, who makes numbers of pigeon-guns for use all over the world, and which have been used with such great success for many years past, could not give his special attention to these clubs only. The author has tested guns of good makers and has found them give very low patterns occasionally, for instance, one shot will give a pattern of 260, the next will not put more than 50 pellets on the target. The larger the charge of powder used the more frequently will this happen. Modified chokes are the worst in this respect; for uniformity of shooting there is nothing like a full choke-bore. The shooting of a pigeon-gun should not be passed which makes a less pattern than 150 with black powder.

THE GAME-GUN.

The best all-round gun for sporting purposes is the 12-bore with 30-inch barrels, weighing about 7 lbs., providing the sportsman can carry and handle a weapon of this weight.

Twelve-bores much under 7 lbs. will not shoot a heavier charge than $3\frac{1}{4}$ drams and $1\frac{1}{8}$ oz. with comfort to the shooter. If $7\frac{1}{4}$ lbs., $3\frac{1}{4}$ drams and $1\frac{1}{4}$ oz. If $7\frac{1}{2}$ lbs., the charge may be $3\frac{1}{2}$ drams and $1\frac{1}{4}$ oz.; over $7\frac{1}{2}$ lbs., guns are usually built for extra-long cartridge-cases and special charges.

The usual full-choked 12-cal. gun with 30-inch barrels, and weighing 7 lbs., should average—

AT FORTY YARDS.

Charge.		Pattern.		Penetration of Strawboards	Mean Velocity.	Force at Impact.
Drams of powder.	Oz. of shot.	Square 10" centre.	30 in. circle.			
3 $\frac{1}{4}$	1 $\frac{1}{8}$ No. 8	92	320	15	800	0'80
3	1 $\frac{1}{8}$ No. 6	55	215	20	839	1'80
3 $\frac{1}{4}$	1 $\frac{1}{8}$ No. 6	51	210	21	857	1'83
3 $\frac{1}{2}$	1 $\frac{1}{8}$ No. 6	39	200	22	912	1'87
3 $\frac{1}{4}$	1 $\frac{1}{4}$ No. 6	58	240	21	864	1'85
3	1 $\frac{1}{8}$ No. 5	35	175	22	878	1'89
3 $\frac{1}{4}$	1 $\frac{1}{4}$ No. 5	45	190	23	882	1'91
3 $\frac{1}{4}$	1 $\frac{1}{4}$ No. 4	40	160	24	900	2'81
3 $\frac{1}{4}$	1 $\frac{1}{4}$ No. 3	38	135	25	950	3'16
3 $\frac{1}{4}$	1 $\frac{1}{4}$ No. 1	35	105	26	980	4'18
3 $\frac{1}{2}$	1 $\frac{1}{4}$ No. 1	33	100	30	988	5'30

AT SIXTY YARDS.

3	1 $\frac{1}{8}$ No. 6	29	110	10	652	0'93
3 $\frac{1}{2}$	1 $\frac{1}{8}$ No. 6	36	100	11	723	1'28
3 $\frac{1}{2}$	1 $\frac{1}{8}$ No. 5	28	89	14	757	1'47
3 $\frac{1}{2}$	1 $\frac{1}{8}$ No. 4	17	70	18	786	2'00
3 $\frac{1}{2}$	1 $\frac{1}{4}$ No. 1	15	50	21	799	2'46

Guns with 27-inch barrels will be found to permit of better marksmanship than with shorter barrels, and consequently, unless there is a good reason for doing so, guns should not be made with shorter barrels than 27 inches.

Light guns and guns with short barrels will shoot 3 drams and 1 $\frac{1}{8}$ ounce of shot, and an average pattern of 200 with No. 6 shot may be obtained. The superiority of this gun to guns of smaller bore may be judged by the following figures.

THE 16-BORE FULL-CHOKE, with barrels 30 inches in length, and the gun weighing 6 $\frac{1}{4}$ lbs., should average—

AT FORTY YARDS.

Charge		Pattern. 30-inch circle.	Penetration of Strawboards	Mean Velocity.	Force at Impact.
Drams of powder.	Oz. of shot.				
2	1 No. 5	160	22	763	0'98
2½	1 No. 6	190	19	814	1'35
2½	1 No. 5	155	23	847	2'49
2¾	1 No. 6	180	21	833	2'27
3	1 No. 6	174	22	858	2'33
2¾	1 No. 5	155	25	856	2'48
2½	1 No. 1	85	29	936	3'00

AT SIXTY YARDS.

2¾	1 No. 6	95	9	635	1'10
2¾	1 No. 5	85	12	675	1'26
2½	1 No. 1	45	19	830	1'52

Weight from 5¾ to 6½ lbs. Recoil 82 lbs. For 16 and smaller bores it is a good plan to have the right barrel an improved cylinder.

THE 20-BORE is the smallest bore sought after by the general sportsman ; a gun of 5½ lbs. weight, and with 28-inch barrels, may be taken as representing fairly the 20-cal. class, and should average—

AT FORTY YARDS.

Charge.		Pattern. 30-inch circle.	Penetration of Strawboards	Muzzle Velocity.	Force at Impact.
Drams of powder.	Oz. of Shot.				
2¼	1 No. 8	230	13	756	0'67
2¼	1 No. 6	180	18	772	1'37
2½	No. 6	160	19	849	1'94
2½	No. 5	120	22	890	2'37
2½	No. 1	65	29	950	2'72
32 grs. Schultze	No. 6	150	20	820	2'00

AT SIXTY YARDS.

$2\frac{1}{4}$	1 No. 6	60	9	650	0'76
$2\frac{1}{4}$	1 No. 5	35	18	684	0'89

Weight not less than $5\frac{1}{4}$ nor more than 6 lbs.
 Recoil under 90 lbs.

THE 28-BORE should have 25- or 27-inch barrels, which will require but little choking, and average—

Charge powder.		30-inch Pattern.	Cardboard penetration.	Mean velocity.	Force at impact.
$1\frac{1}{2}$ drams	$\frac{3}{4}$ oz. No. 8	150	13	705	0'66
*32 grs. Schultze	$\frac{3}{4}$ oz. No. 6	124	22	940	1'96
$1\frac{1}{2}$ drams	$\frac{3}{4}$ oz. No. 6	130	27	720	1'87

* Over-loaded. This charge has been too frequently used ; 26 grains does better.

The weight should not be less than 4, nor more than $4\frac{3}{4}$ lbs. Recoil 60 lbs. The 28-bore must not be loaded with 1 oz. of shot, as is too often done. This calibre especially is too frequently much over-loaded.

THE FLIGHT OF A CHARGE OF SHOT.

The shooting powers of a gun and the relative values of various loads, powders, etc., used in it are ascertained by comparing the pattern, penetration, velocity, stringing, spread and range of the shot fired.

The pattern is the *shown* shooting of a gun, the only visible proof of a gun's powers—the killing of game being in some measure dependent upon the skill of the sportsman. The *pattern* of a gun, besides being the most reliable test applicable to a gun, is fortunately the easiest. To ascertain a gun's

merits, fire it at the largest sheet of paper obtainable—for most guns forty yards will be found the best distance. For comparative results count the number of perforations formed in a circle 30 in. in diameter marked upon the paper. A good close pattern is a guarantee that the gun has sufficient force to kill at that distance. The greater the velocity of the *mass* of pellets of the charge the closer is the pattern. No close-shooting gun has inferior penetration, and, generally speaking, the less distant each individual pellet is from the common centre depicted on the target, the less is the distance between the first and last pellets of the charge—in other words, a *close* pattern means uniform velocity in the pellets of the charge. Occasional bad patterns, or patchy patterns, prove the gun to be improperly bored. The closer the pattern at forty yards, the longer the killing range of the gun.

Penetration is the result of the velocity of the shot.

The velocity of shot depends upon the nature and quality of the explosive used, the perfect finish and shape of the barrels, the rotundity, size, and specific gravity of the pellets. The details of the various deviations in results obtainable by different grains of powder, different gauges of guns, different sizes of shot, chokes and cylinders, would be tedious.

Stringing of the charge is the result of the different velocities of pellets in the one charge; for instance, with a cylinder gun, 42 grains of nitro-explosive and $1\frac{1}{8}$ ounce of No. 6 shot, the front pellets

reach the target in $\frac{1}{38}$ of a second from the time of leaving the muzzle, but the last pellets to reach the target arrive after the expiration of $\frac{1}{187}$ second.

This means that whilst the first pellets may strike a bird at forty yards the slower pellets have not reached a distance of thirty yards from the gun.

As a matter of fact, about 5 per cent. of the pellets of the charge arrive simultaneously at the target at forty yards distance from the gun ; these pellets are *closely* followed by 25 per cent. to 30 per cent. of the pellets of the charge if the gun be a good one, and this 30 per cent. to 40 per cent. of the pellets represents practically the actual killing value of the shot, for the remaining pellets flying irregularly, and at a much lower velocity, tail off so rapidly that little reliance can be placed upon them.

The spread of the charge of shot or its divergence from the line of flight differs with individual guns, it being the gun-maker's object to make the shot fly compactly. A few stray shots from the charge will occasionally diverge to the extent of twenty yards at a range of forty yards, 16, 18, or 20ft. is the usual limit of the divergence of outside pellets, at forty yards' range. Guns bored cylinder, and guns with sudden chamber cones cause the shot to spread more irregularly than choke bores.

The range of a gun is dependent upon the velocity of the pellets of the charge, a gun in which the spread and stringing are less has a greater range than one which will send a few pellets at

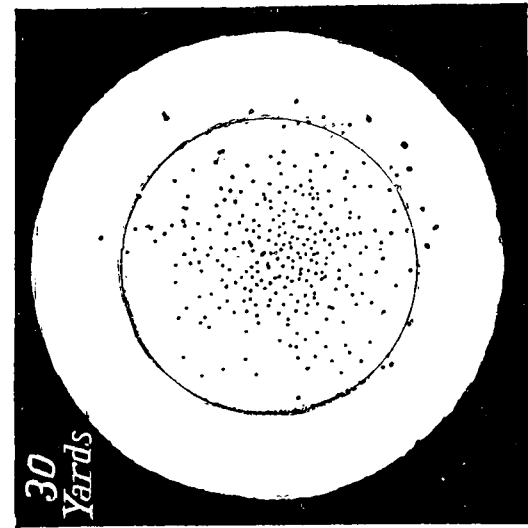

Choke at 30 Yards.

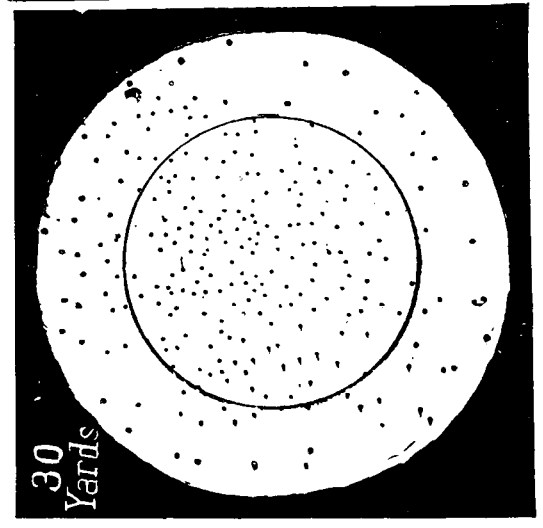
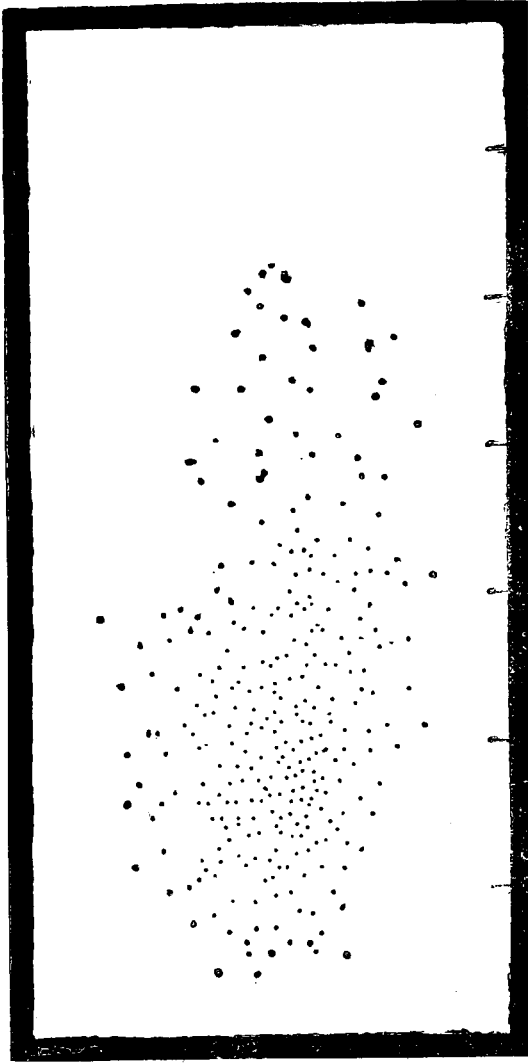

Cylinder at 30 Yards.

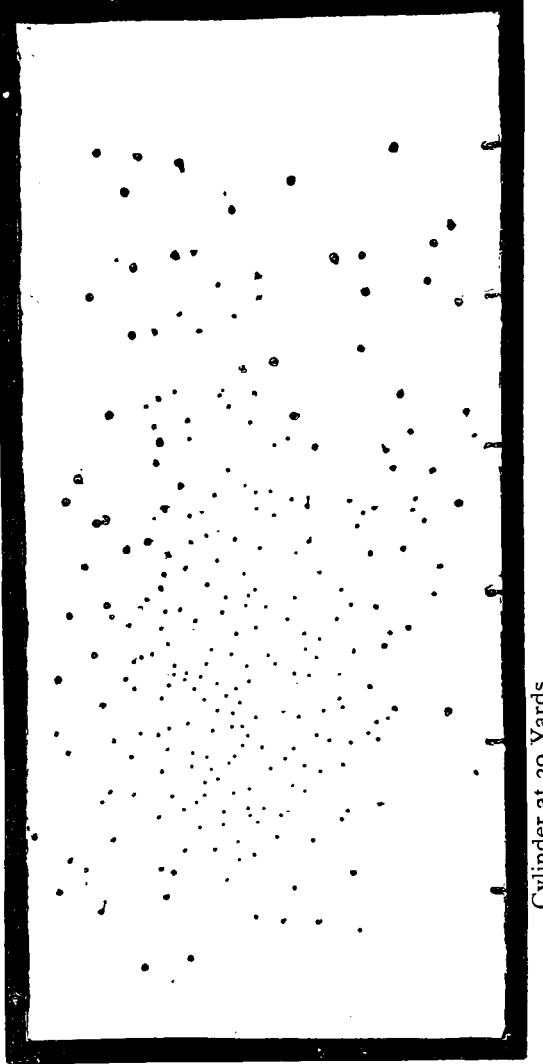

high velocity: there is the momentum of the charge in flight as well as the momentum of the individual pellets of which it is composed.

It is impossible, without going deeply into figures, to prove the many variations in the flight of a charge of shot caused by differences in the loading, size of shot, size of bore of the gun, grain of powder, composition of powder, and other matters which more or less modify a gun's shooting. We reproduce a few standard diagrams and figures for reference, but must refer the reader interested in the subject to "Modern Shot Guns" for further details upon these points.

CHARGE.		5	10	15	20	25	30	35	40	45	50	55	60
		Yds.	Yds.	Yds.	Yds.	Yds.	Yds.	Yds.	Yds.	Yds.	Yds.	Yds.	Yds.
drms. oz.													
2½	I No. I	1039	1022	1001	979	951	929	904	880	856	829	802	780
3	I „ I	1185	1168	1150	1120	1076	1039	992	939	919	880	852	831
3	I ⅛ „ I	1169	1140	1126	1089	1054	1003	962	935	914	891	861	825
3½	I ⅛ „ I	1220	1198	1175	1143	1103	1060	1012	966	938	914	890	876
3½	I ¼ „ I	1172	1151	1130	1111	1073	1029	989	949	908	867	835	799
4	I ¼ „ I	1239	1221	1205	1181	1144	1106	1066	1022	976	936	909	863
2½	I „ 5	996	975	953	924	886	850	831	792	771	744	710	684
3	I „ 5	1160	1133	1106	1066	1021	969	922	879	840	801	764	729
3	I ⅛ „ 5	1127	1034	1070	1047	1014	970	914	875	835	790	741	672
3½	I ⅛ „ 5	1182	1164	1136	1088	1045	1002	960	907	875	838	799	757
3½	I ¼ „ 5	1130	1111	1088	1058	1026	979	931	880	834	790	741	689
4	I ¼ „ 5	1207	1190	1171	1134	1094	1051	994	932	892	853	810	764
2½	I „ 6	990	963	941	905	863	829	804	776	752	722	690	651
3	I „ 6	1154	1130	1100	1061	1012	950	904	862	826	770	730	694
3	I ⅛ „ 6	1119	1091	1063	1035	999	942	890	850	808	769	717	652
3½	I ⅛ „ 6	1175	1153	1120	1079	1032	986	940	894	861	825	780	723
3½	I ¼ „ 6	1121	1100	1081	1050	1015	970	912	858	810	762	714	663
4	I ¼ „ 6	1199	1177	1159	1122	1082	1034	977	907	850	816	774	734
2½	I „ 10	922	892	872	841	802	760	703	670	622	551	465	370
3	I „ 10	1120	1094	1071	1029	959	891	809	751	704	630	559	440
3	I ⅛ „ 10	1076	1041	999	941	886	831	775	710	540	465	430	375
3½	I ⅛ „ 10	1126	1096	1060	1012	965	892	830	781	711	630	550	460
3½	I ¼ „ 10	1066	1041	1017	980	940	896	834	760	706	620	540	446
4	I ¼ „ 10	1145	1115	1090	1045	987	927	904	792	720	642	551	495

All these figures were obtained with a Greener-choke 12-bore gun, with Schultze powder and good wadding. Inferior wadding will produce lower velocity, especially at the longer ranges.

CHOKE-BORES *v.* CYLINDERS.

The larger the killing circle and the greater the range, the greater the efficiency of the gun. To make a charge of shot fly compactly, to increase the velocity of the mass of the pellets, to prevent the divergence or straying of the shot, it has been found that the choke-boring of the gun is most effectual.

The adjoining diagrams will give at a glance an approximate idea of the difference in the flight of a charge of shot from a choke-bore and a cylinder gun, and also the difference caused by an increased charge of powder in the choke, but as the velocity varies at the different ranges, the diagrams do not show accurately the approximate divergence at all ranges.

The *best pattern* is that of the choke-bore gun, and sportsmen seem slow to grasp the fact that pattern is the all-important factor in the killing range of the gun. The author made a series of experiments by which he ascertained that it requires at least four pellets of No. 6 shot (chilled) to kill a pigeon, excepting, of course, such flukes as a pellet striking the head or breaking the neck, and the pigeon, if struck by six shots, none of

which might prove immediately mortal, should be dropped at once by the aggregate. An old or true cylinder gun will not, upon the average, put three pellets into a pigeon thirty yards distant. The cylinder gun must, therefore, be considered practically useless at this distance; for, providing the pigeons were fairly struck, and in the centre of the charge, not more than one out of three would be killed and gathered. To ensure four pellets being put into a pigeon, a pattern of at least 200 in the 30-inch circle is necessary. It is possible to kill pigeons at forty yards with a choke-bored gun if so small a charge as $2\frac{1}{4}$ drams and $1\frac{1}{4}$ oz. of No. 6 shot be used; with a pattern of 240 in the 30-inch circle the value of penetration is lessened. Whereas, unless the pellets *strike* the bird penetration is quite useless; pattern never is.

A gun, by varying the load, can always be made to spread, so that for covert or rabbit shooting a choke-bore gun, loaded with scatter charge and the quantity of shot slightly reduced, may be used with better effect and less danger than a cylinder. There is a prejudice against choke-bores amongst a certain clique of English sportsmen, but the system of boring has such enormous advantages and adds so greatly to the gun's range and power that it continues to gain rapidly in favour.

The barrel may be contracted from, say 5,000ths of an inch, being then almost cylindrical, to

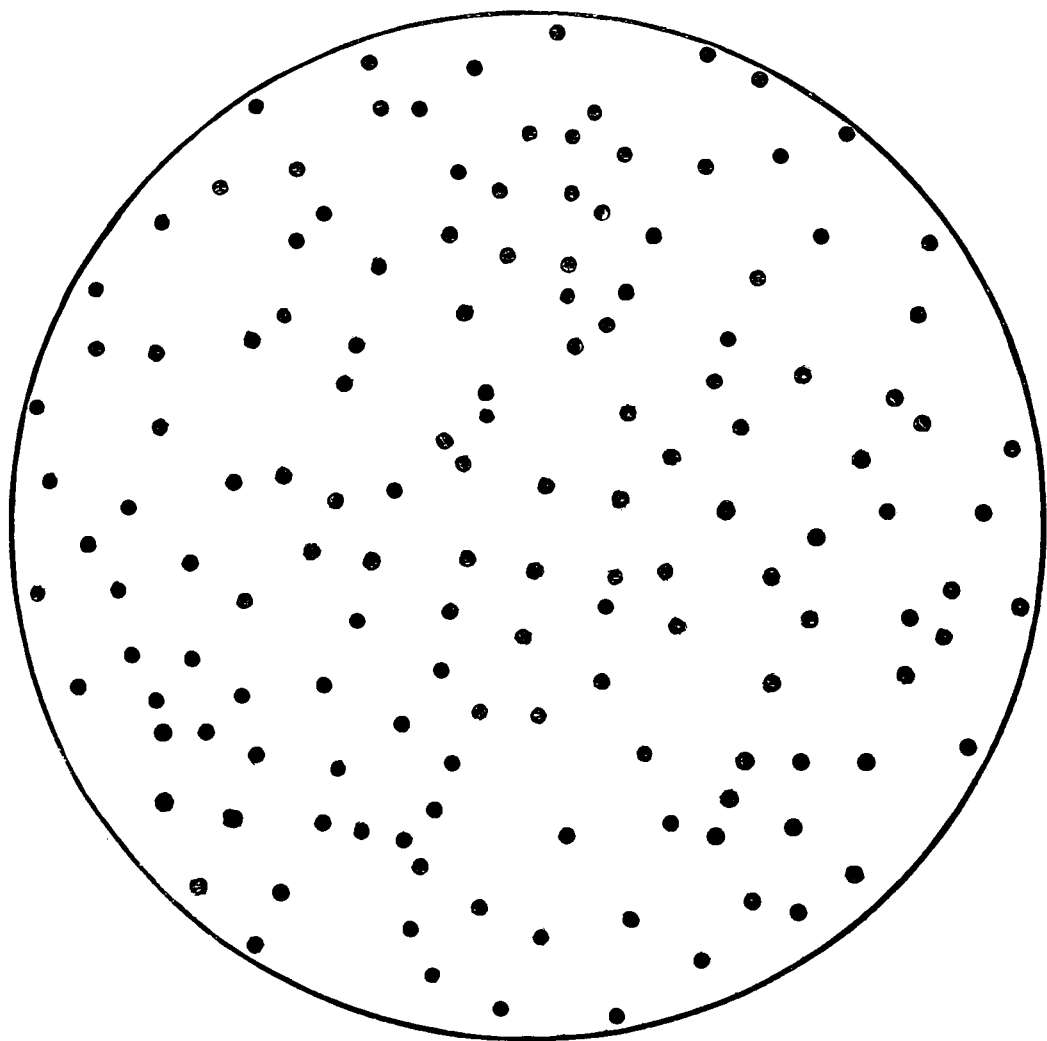

Facsimile of Shooting of an Improved Cylinder at forty yards.

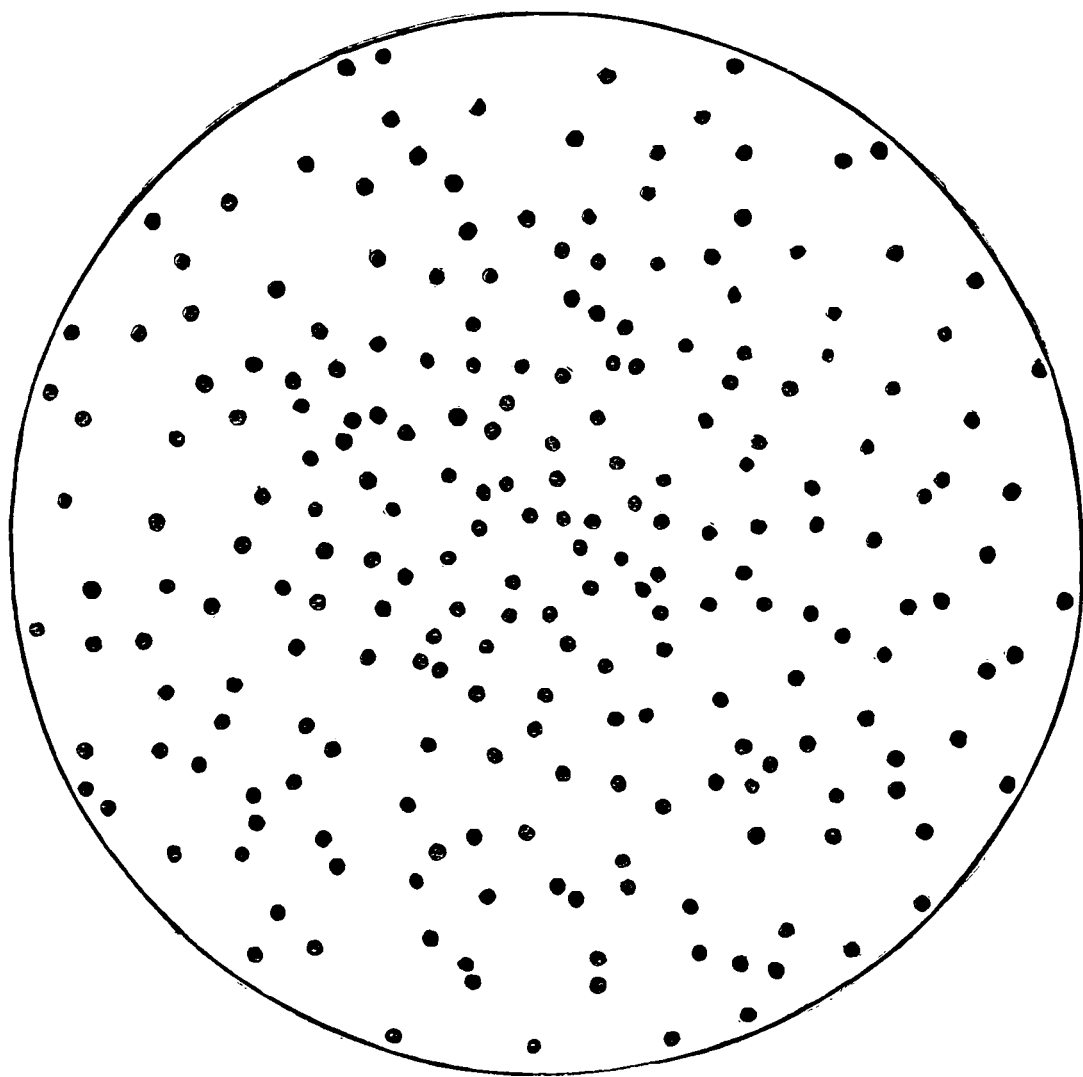

Facsimile of the Shooting a W. W. Greener Gun with Schultze Powder
and No. 6 Shot (reduced by photography).

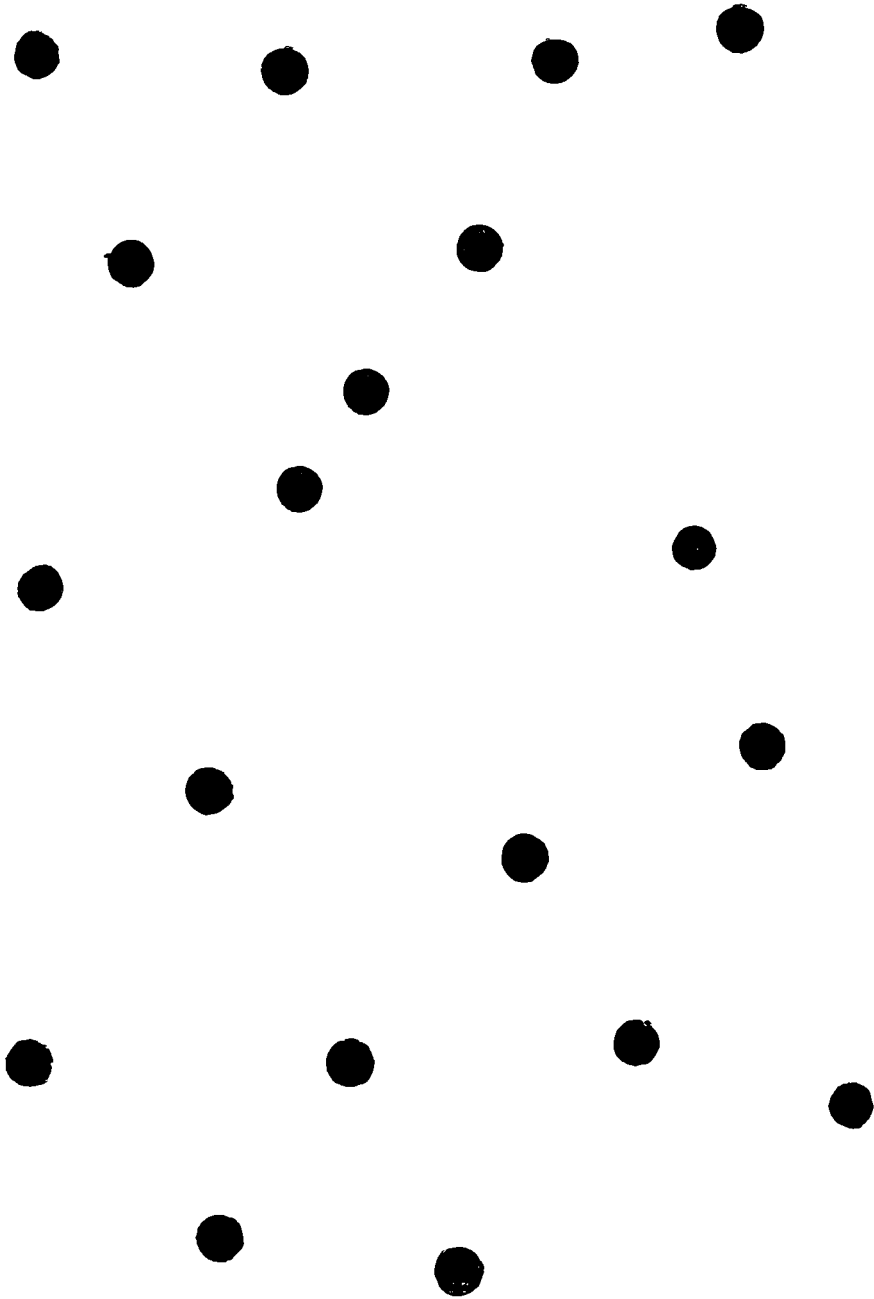

Fac-simile of the Shooting of a Full Choke bored Gun at 40 Yards,
3 drams of No. 4 Powder, and $1\frac{1}{8}$ oz. No. 6 shot.

These two illustrations represent exactly the distance the pellets are
apart; those reduced by photography may convey a wrong impression
on account of their reduced scale not being taken into consideration.

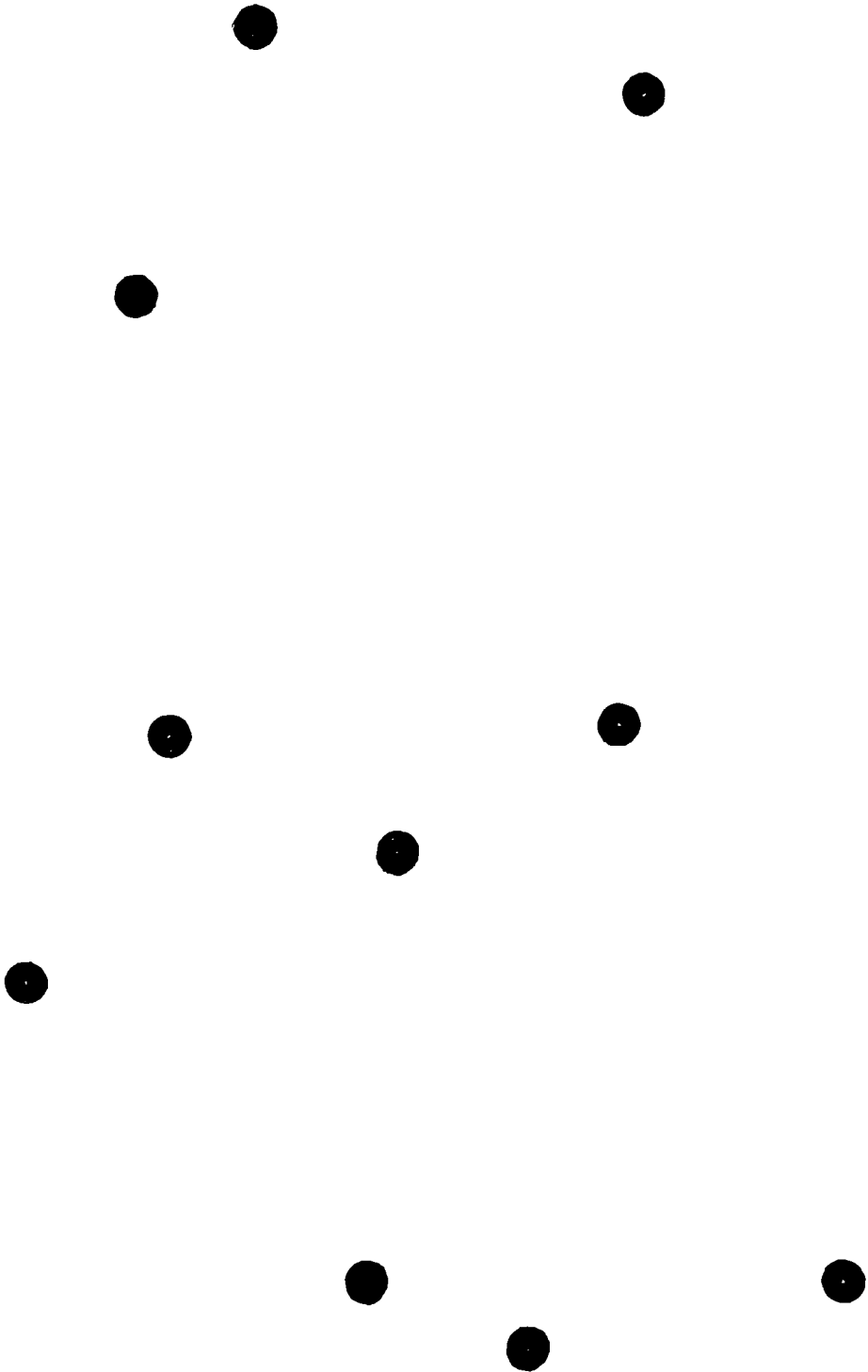

Fac-simile of the shooting selected from the centre of the pattern or an improved cylinder bored gun, at 40 yards, 3 drams of No. 4 powder, and $1\frac{1}{8}$ oz. No. 6 shot.

K

33,000ths of an inch when it is an extra full choke. The graduations are as follows :—

With a twelve bore gun, standard load distance and conditions, the ordinary <i>full choke</i> will make an average pattern of	215 pellets
The half-choke	185 „
The quarter-choke	160 „
The improved cylinder	140 „
The old, or true cylinder	115 „

Better shooting than average of 215 can be obtained from an extra full-choked bored 12-bore gun, by using Schultze E.C. or S.S. powder. $1\frac{1}{4}$ oz. of shot improves the pattern of choke guns from 10 to 30 pellets when using No. 6 shot, it fills up the pattern just round the 30-inch circle.

No increase in the charge of shot will improve a cylinder.

OF CHOKE-BORES AND CYLINDERS.

A gun must be more or less choke-bored, unless the sportsman wishes to handicap himself needlessly. The invention of choke-boring is certainly as important as any of the improvements introduced into the firearms industry during the last half century, and notwithstanding the assertions of misinformed persons to the contrary the choke is rapidly growing in public favour. Not only does choking cause the gun to shoot more closely ; it

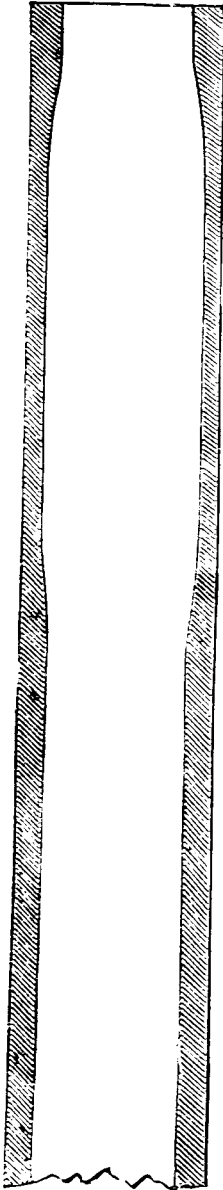

The Recess, or Fairburn Choke.

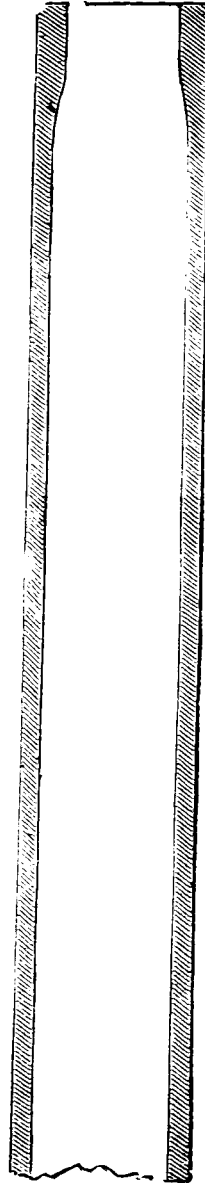

The True, or Greener Choke.

also makes it shoot more regularly, more uniformly, and, to a very great extent, prevents the erratic flight of a few pellets in a line widely divergent to that taken by the body of the charge. For ordinary sporting purposes a gun which shall give its largest killing circle at 30 yards with the first barrel, and at 40 with the second, will be found the most convenient of good shots. This means a pattern of 140 to 150 at 40 yards with the right barrel, and 200 to 210 with the left. The patterns of the first barrel at 30 yards, and that of the second at 40 yards, when compared with each other, will be about the same, both with regard to spread and number of pellets in the 30-inch circle.

The difference between the size of the killing circle of the right and left barrel at 25 yards would be very little, both being about 24 inches, but at 20 yards the cylinder would have killing circle 2 to 3 inches larger.

With the old, or true cylinder, at 20 yards the spread would be larger and the pattern patchy and irregular, so that a bird might sometimes escape when within a few inches of the centre of the charge. At all distances these patterns are very irregular, sometimes shooting so wildly that they do not put 30 pellets on the target.

It has been stated by some writers in favour of cylinders that they will give a greater killing circle than 30 inches.

The author never saw the cylinder that could

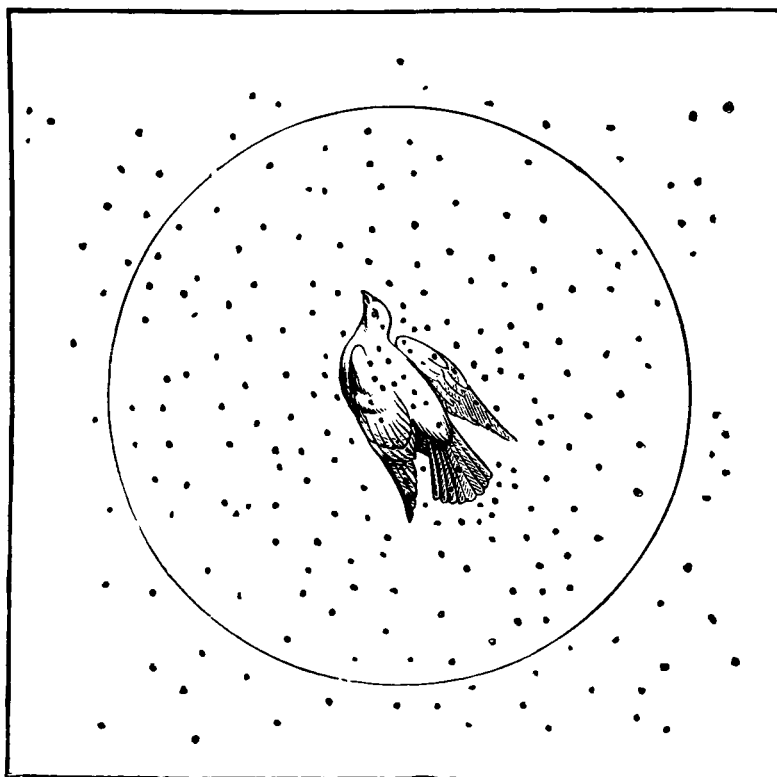

Facsimile.--Circle, 30 in. diameter, Plate 4 foot.

Number of pellets in circle, 250. Killing circle, 35. This diagram represents the shooting of a pigeon-gun, 12-bore, with 4 drams and $1\frac{1}{4}$ oz. No. 6 shot.

be relied upon to do it. The pattern outside the 30-inch circle is so thin and patchy that it cannot be expected to kill.

Excellent shots may have the range extended ten yards, if possible, and indifferent shots the range reduced ten yards. It is the ability of the shooter to aim the gun which will determine the amount of choke. The fullest choke-bore will not "riddle" a partridge at twenty-five yards, but as the spread of the shot at that distance will be smaller than the killing circle of the gun at forty yards, a true aim must be taken. It is easier to correctly align a gun at twenty than at forty yards, and the indifferent shot, whose poor shooting arises from the inability to aim, should avoid long shots. The poor shot who misses from nervousness should try long shots. A very little practice will give much more knowledge on the subject of a suitable choke than any number of instructions.

There is but one cylinder. It is useless to expect patterns, penetration, and velocity from a cylinder-barrel which are beyond the capabilities of the cylinder-bore, and go to whomsoever you may, if you want closer patterns, greater penetration, or more uniform shooting, he must "improve" the cylinder by choking to give you what you want. For a trap-gun a full choke is absolutely necessary. For a game-gun the pattern may be reduced, but it is rarely advisable to purchase a gun which will not make an average pattern of at least 140 with either

barrel, which is in reality a modified choke. The choke can always be so loaded as to equal the cylinder in wideness and regularity of spread, but no gun-maker, or sportsman, can load a cylinder to shoot as closely and evenly as the choke.

Any number of instances might be cited which illustrate the immense superiority of the choke-bore. For all-round game-shooting there is certainly nothing to equal it, and as a trap-gun it is invariably used. The choke has no disadvantage. It may be too close in its shooting for certain game at short ranges, but this is a fault at once remedied by having a special load for the choke-gun when a large spread at short range is required. It must, however, be remembered that a cylinder-bore gun at fifteen yards range has put fifty-four pellets of No. 6 into a pigeon, and that a choke at twenty yards will not average more than forty, even if "dead on" each shot. The choke may be used for wild-fowling for rough shooting, and it will, in many instances, enable the good shot to secure game, where he would, if restricted to the cylinder, have no chance whatever.

HOW TO LOAD A GUN.

The standard loads of guns for various gauges have already been given in this chapter. The sportsman must, however, remember that the closeness of a gun's shooting may generally be improved by the use of Schultze gunpowder, if the gun is

full or modified choke. The No. 4 black powder is that usually best suited to guns from four to twenty-eight gauge.

As to the size of shot, No. 6 of 270 to the ounce is the standard for 12-bores, in which also every size may be used.

The 28-bore will do relatively better with eight or seven than with six or five, and with a 4-bore gun anything smaller than No. 3 is wasted.

Modified choke-bores and cylinders give a larger killing circle the smaller the shot. 20, 16, and 12-bore cylinder barrels may be used at the ordinary winged game of Great Britain with greater success if charged with No. 7 than with 5 or 6. In 12-bore guns it is not wise to load with larger shot than No. 4, unless the gun has been regulated for use with a certain size of large shot. For 10-bores No. 1 size is the limit. These remarks must not be construed to mean that the 12-bore game-gun must always be used with one size of shot ; for quail and young partridge shooting No. 7 may be employed to advantage, and for shore shooting even larger size than No. 4. But the sportsman must remember that when he uses the large shot he is sacrificing closeness of shooting for the extra benefit he obtains from the increased range and smashing power of the large shot. Cartridges loaded with nitro-compounds must be well turned down.

Good close shooting in guns of any bore can only be obtained by using cartridges loaded

rationally, and to be rationally loaded there must be good wadding between the powder and the shot. The secret of good shooting is in the employment of a first-class felt wad over the powder ; and it is imperative that this wad be of good quality. The texture must be close and firm, but the relative hardness or softness of the wad is of less moment. It should be of the same diameter as the internal diameter of the cartridge-case in which it is to be used— $\frac{3}{8}$ or $\frac{7}{16}$ thick for 12-bores, thinner for smaller bores, and thicker for larger bores. To protect the *powder* from the injurious effect which may result from continuous contact with the chemically-prepared felt wad, a thin card wad or a waterproof wad should first be inserted ; and it is supposed to be conducive to closer shooting if this protective wad, instead of being a simple card wad, be a compound paper and felt wad — technically known as the “pink-edged” or “FIELD” wad. This “Field” wad should always be used when loading with nitro-compounds ; with black powders its use is not so imperative. It is customary to place a third wad, of thin card, between the thick felt wad and shot, but it is very doubtful if any benefit will accrue from its use.

The cartridge loaded for close shooting will, therefore, be charged, as in the illustration on next page.

Heavy charges of powder are a mistake. Using larger charges in a 12-bore than $3\frac{1}{2}$ drams, or the

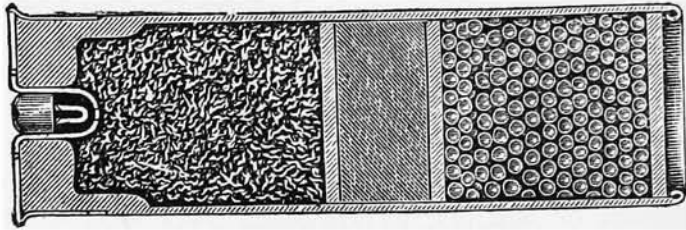

Cartridge Loaded for Close Shooting with Black Powder.

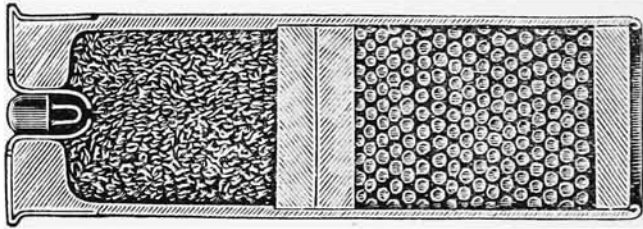

Cartridge Loaded to Scatter.

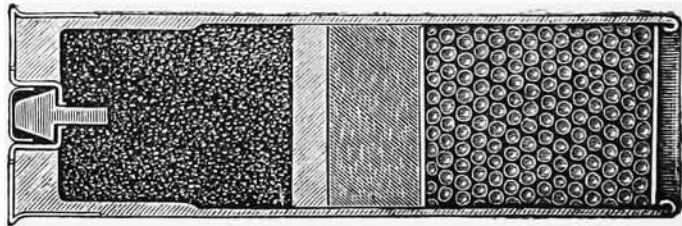

Cartridge Loaded for Close Shooting with a Nitro-compound.

equivalent in nitro-powders, no matter what weight the gun is, only scatters the charge, and spoils the regular shooting of the gun.

Loading with two pink-edge wads over the powder, and one pink edge wad over the shot, as

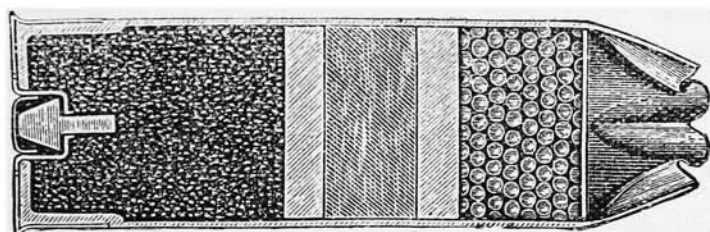

Brass Cartridge Case Wadded for Close Shooting.

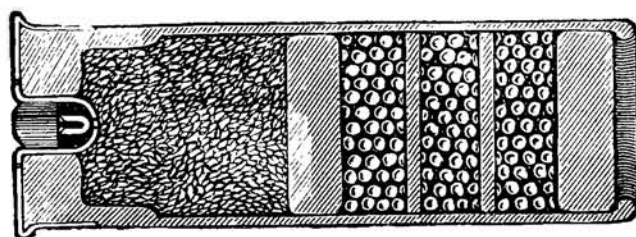

Cartridge Loaded to Scatter the Shot.

is often done in the United States, causes the charge to scatter, and such loading will lower the pattern 15 per cent. in a gun fully choke-bored.

If charged with "Schultze" or "E.C." gun-powder the wads used will be the pink-edged or "Field," the thick felt and the thin card as shown.

If brass cases are to be loaded for close shooting, put the wads, as illustrated, between the powder and shot, and crimp the case.

When loading long 12-bore cartridge-cases, $2\frac{7}{8}$ or 3 inches, with large charges of powder, two thick felt wads (soft and elastic) should be placed over the powder, and a thin card over shot, to obtain the closest and most regular pattern.

To load choke-bore guns so as to scatter the shot at close quarters diminish the thickness of wadding between the powder and shot, and increase it over the shot. This is pretty effective, but the best plan is to load as illustrated.

The charge of shot, it will be seen, is separated by two cardboard wads. This will cause a full-choke-bore gun to make a pattern of 140 at 40 yards instead of 220. A still smaller pattern may be obtained by using one ounce of shot instead of the ounce and eighth, and still further by substituting No. 5 for No. 6 shot. If it scatters too much, separate the shot by one wad instead of two, or by simply using one pink-edged wad only over the powder, and one over the shot.

The scatter-charge has good penetration at 30 or 40 yards, but of course not so much as when loaded for close shooting.

For rabbit shooting, with a full-choke-bore gun, at 15 and 20 yards' distance, very successful results have been gained by reducing the charge of shot

to $\frac{1}{2}$ oz., the smashing of the game being thus avoided.

There is an idea prevalent that by diminishing the charge of powder below the standard charge, and keeping the standard charge of shot, the closeness of the pattern will be increased. This is erroneous, so far as it applies to guns choke-bored, and the use of black gunpowders, and in any case it is productive of irregular shooting and patchy patterns.

By overloading the gun with powder and shot, or with powder only, irregular patchy and open patterns are produced.

When small charges are used the cartridges should not be shortened by cutting down or turning over beyond the usual limit but by filling the space with wadding—or the case may be slightly turned down, and then crimped, as are the thin brass cases.

It will be found to be true economy to purchase just such cartridges as are required for the sport purposed than to use unsuitable loads. For partridge shooting use the *Sporting Life* cartridges; they are also suitable for grouse shooting, and may be looked upon as amongst the best for all-round purposes. For shooting in pigeon matches and at wild fowl use the very best cartridges procurable, and by no means employ reloaded cases.

For rabbit shooting a cheap cartridge may be purchased, but such cartridges should not be stored.

It is economical to work up old, damaged, mixed, or suspected cartridges at a rabbit shoot.

SELECTING BUCKSHOT.

To select a buckshot which will suit a particular gun, put a wad in the muzzle of the gun about $\frac{1}{2}$ an inch down, and fit the shot in perfect layers. There will be no need to try them in the cartridge cases, as it is immaterial how they fit there. Buckshot of a size which will average 9 pellets to the $1\frac{1}{8}$ oz. will generally fit a full choke-bored 12-gauge gun, the three shot to the layer. If a smaller shot be required choose four or five to the layer, avoiding sizes which do not fit fairly well; with such well-chosen buckshot nearly the whole of the 9, 12, 16 or 20 shot of the charge will be in a circle of about 30 inches diameter at 40 yards' range, if the gun is of good quality and properly bored.

SHOT-GUNS AS BALL-GUNS.

It is well known that the ordinary double-barrelled cylinder shot-gun will shoot spherical bullets with fair accuracy up to fifty yards.

The recoil felt by firing a light 12-bore gun with a spherical bullet is very considerable; as a matter of fact the recoil is 13 lbs. heavier with the bullet and the standard charge of powder than with the standard charge of shot.

Choke-bore guns may be used as ball-guns, providing that the bullet to be fired will pass easily

through the muzzle; and it may be interesting to sportsmen to know that choke-bore guns shoot ball *quite as well* as guns bored perfectly cylinder. Especially is this of interest to those who use but one gun, and have often the chance of a shot or two at big game. Gun-makers and sportsmen alike have been misled by the proof marks; formerly, on all choke-bores "Not for Ball" was imprinted.

Another point to be noticed is that when one barrel be modified choke or cylinder it is only necessary to use the one-sized ball, the larger bored barrel shooting, to all intents and purposes, as well as the barrel for which the ball is moulded.

Any gun which is safe to use with shot is quite as safe with ball, provided that ordinary care be taken to see that the ball be not larger than the smallest part of the barrel, and the charge of powder does not exceed $2\frac{1}{2}$ drms. of powder No. 4, or No. 6, black, for light guns, and $2\frac{3}{4}$ to 3 drms. for heavier than 7 lbs. One card and one thick felt over the powder, the ball being fixed in either by an ordinary turnover or crimper, will give all that is desired. *Neither wad nor patch over the ball.*

Bullets cast in a 14-bore mould will invariably suit a full choke, and 13 bore for cylinders.

CHAPTER VI.

A MISCELLANEOUS CHAPTER—GUNPOWDERS—
NITRO-EXPLOSIVES — SHOT — CARTRIDGE-CASES
— LOADED CARTRIDGES — GUN-CASES, ETC.
ETC.

GUNPOWDERS.

THE explosive used in shot guns is either black gunpowder (saltpetre, charcoal, sulphur) or a nitro-compound (carbon base, treated with nitric and sulphuric acids). The black gunpowder is granulated, the grains being of various sizes, ranging from dust to $1\frac{1}{2}$ -inch cubes for use in cannon.

The ingredients of best black gunpowder are in the following proportions: saltpetre 75 per cent., charcoal 15 per cent., sulphur 10 per cent.—and this is the proportion generally followed by English and the best foreign makers.

The explosive force is generated by the saltpetre and charcoal; the sulphur raises the temperature of the freed gases, and adds to their volume by its own decomposition. The speed with which a charge of powder explodes is due to the size and density of grain. This question of grain is of the first importance to the sportsman.

No. 4 is unequalled for all-round shooting in

guns of any gauge. For 12 and smaller bores, when strong shooting is required, the No. 4 alliance, having a larger proportion of the finer grains than is usually found in ordinary No. 4, will be found to give satisfactory results. This powder would not be obtained by mixing No. 3 and No. 4 together in *any* proportions, but would require to be specially sifted.

To sum up the question of grain in one sentence: whilst No. 6 gives regular and even patterns, it has not the velocity of smaller grained powders; the

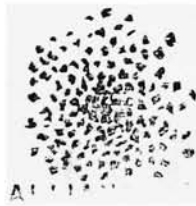

No. 4 Alliance Powder.

Nos. 3, 2, and 5 grained "Basket" cause the pellets to scatter more rapidly than the larger grained powders; the No. 4, therefore, is the happy medium for the ordinary purposes of the field and trap shooter.

The best gunpowder requires the very best alder-wood or dog-wood charcoal, refined sulphur, and the purest saltpetre. These three ingredients must be *thoroughly* corporated, and the powder submitted to great hydraulic pressure, before being broken up and granulated.

The charcoal of inferior quality, or badly burnt

or of the wrong wood, will spoil the quality of the powder, whatever pains be taken with the subsequent stages of manufacture.

The brown, or cocoa powders, recently introduced, owe their colour to a different treatment of the charcoal, and these powders have no special quality to recommend them for sporting purposes.

TO TEST THE QUALITY OF GUNPOWDER.

Rub a few grains in the palm of the hand, or between the finger and thumb. If it is reduced to dust with little pressure, its density is insufficient, and the quality poor; if the colour of the dust is of inky blackness, the charcoal is of inferior quality, and the powder poor in consequence. Good gunpowder can scarcely be reduced to dust by rubbing in the hand; the dust will be of a rich dark brown, and if a little powder be ignited in a piece of paper, no residuum should be left, nor the paper burnt through.

These rough and ready tests are not of course equal to trying the powder in a gun of known quality or to laboratory tests, for flashing point which should be 600° F., etc.

The chief nitro-explosives are the "Schultze" "E. C." and the "S. S." or Smokeless, they are made by impregnating some carbon basis, cotton or wood pulp, with nitric acid and purifying them by chemical means. Schultze is the oldest and best known, it is made from pulped wood which, after nitrification and purification, is granulated and water-

proofed ; " E. C. " is granulated gun cotton water-proofed and treated in a special manner. The " S. S. " of the Smokeless Company is a chemically prepared powder, and the Company manufacture other powders of a quite different nature for rifles.

Nitro-powders possess various advantages over black, the chief being the absence of smoke after the discharge, and the small amount of residue deposited in the barrel. This is on account of the greater percentage of available gases contained in nitro-compounds to that of gunpowder. Black gunpowders usually give about 65 per cent. solid residue and 35 per cent. available gases, which, of course, have to drive out of the barrel the solid residue, in addition to the charge of shot and wads in front of it, the major portion of the solids being in a state of fine division or smoke. The best wood powder will give about 30 per cent. solid residue, 70 per cent. available gases ; consequently, one-half the charge of powder by weight is equivalent in force to a full charge of black powder. This leaves, therefore, only about 15 per cent. solid residue to be expelled from the barrel, against nearly 65 parts solids from black. The solids resulting from the wood powder are expelled in a coherent form instead of smoke, thus slightly lessening the recoil.

Unconfined wood powder, in common with other nitro-compounds, may be ignited without obtaining a third of the available explosive force ; to get the best results the ignition must be made by a detonator

The detonating powder contained in the ordinary sporting cap is sufficient for a sporting charge.

Black gunpowder, on an average, will fire at a temperature of 539° Fahr., whilst nitro-cellulose or "E. C." and Schultze powder increases in a greater ratio than black, and when heated requires less detonation.

The strength of nitro-compounds generally is better developed when the detonator is in actual contact with the explosive. The flash alone of an explosive cap would not develop nearly so much energy from the powder as would a detonator fired in the middle of the charge; but the explosion would be stronger than if the charge were fired by insertion of a heated wire, or by the application of a flame.

All nitro-compounds are more violent in their action the more tightly they are confined and the stronger the detonation by which they are exploded.

The pleasure of shooting is so greatly increased by the use of these smokeless powders that they are rapidly superseding black gunpowders for all sporting purposes. Powders so carefully made as the "Schultze" may be relied upon as safe to use, provided not more than usual sporting charges are employed. An increased load of shot permits of greatly increased explosive force being developed by chemical powders in the chamber of the gun, and consequently it is important to adhere to those proportions of powder and lead which have been

found generally suitable for the guns of various calibres.

In large-bore guns and when large charges of shot are used the use of black powder is recommended as it is far safer than nitro-compounds.

Avoid fine grain powder, as it is likely to burst the barrel on account of its quick ignition; this applies even more especially to rifles. Never use nitro-powders in rifles unless it is made specially for rifles and so marked.

Powders of the chemical class, other than those above cited, must be used with great care unless the sportsman has actual proof that they are absolutely safe in guns of usual strength, the risk will always be somewhat greater than that which follows the use of black.

This applies more especially to nitro-compounds of foreign manufacture, many of which develop an increased internal pressure which renders them unfit for use in light guns.

SHOT.

Lead shot is of two kinds: that which is moulded, as large buckshot, and that which is "dropped," as the ordinary small shot.

Drop shot should be made of lead without a tin alloy; it may be hardened by the patented process of the Newcastle Chilled Shot Company. Hard shot is preferable to soft for all purposes, but it is more expensive. The hardest, heaviest, and

roudest shot made in the world is that manufactured at Gateshead by the Newcastle Chilled Shot Company. The hardest lead shot will not injure a gun-barrel, even if the barrel be of soft Belgian metal.

It is well known that sometimes several shots of a charge will take an erratic flight, but it has been fully proven that chilled shot is less prone to thus fly off at a tangent than soft shot, and this whether the gun used be choke-bored or cylinder. Therefore it is much safer to use.

The nearer to a perfect sphere each pellet of a charge is when the charge leaves the muzzle, the nearer perfect will be the flight of that charge. In passing through the barrel the shot, by pressing against one another and the barrel, become deformed unless they are of hardened metal. Chilled shot will improve the shooting of any gun ; it does not lead so much as the softer shot, and if made as it is by the Newcastle Chilled Shot Company is of the same specific gravity and free from poison as soft shot, whilst as a projectile it is superior in every way.

American and Continental shot is not so regular either in size or shape as the best English shot, and as there is no recognised standard gauge, and instead of testing what a gun will do with No. 5 or No. 6 of a particular make, it will be better to give it as the number of shots to the ounce as 270, 218, 450, etc.

No. 6 shot of different makes as sold in England will vary as much as 100 pellets to the ounce, so it

may readily be seen that unless a person knows the exact number of pellets to the ounce of shot he is using he could easily be deceived as to the gun performance at a target.

The following are the sizes sold by different makers ; but, except in one or two cases, these figures are not strictly adhered to by the makers themselves :—

STANDARD SIZES OF ENGLISH SHOT.

LANE AND NESHAM, LONDON.		NEWCASTLE CHILLED SHOT CO., GATESHEAD-ON-TYNE.	
Size.	No. of Pellets to the Ounce.	Size.	No. of Pellets to the Ounce.
A A A A	30	A A A	40
A A A	35 to 40	A A	48
A A	40	A	56
A	45	B B B B	56
B B B	50	B B B	64
B B	58	B B	76
B	75	B	88
1	80	1	104
2	112 to 120	2	122
3	135	3	140
4	175 to 180	4	172
5	218 to 225	5	218
6	278 to 290	6	270
7	340	6*	300
8	462	7	340
9	568	8	450
10	985	9	580
Dust	1672	10	850
*S G	11	11	1040
*S S G	15	12	1250
*S S S G	17	Large Dust.	1700
*L G	5½	Small Dust.	2800
M G	9	S G	8
—	—	S S G	11
—	—	S S S G	14

* Walker, Parker, & Co. London sizes.

SIZES OF AMERICAN DROP SHOT.

T. N. SPARKS, Philadelphia.		TATHAM BROS., New York.		N. Y. LEAD Co., New York.		LE ROY Co., New York.		ST. L. SHOT Co., St. Louis, Mo.		SELBY Co., San Fran- cisco.		CHICAGO Co., Chicago, Ill.		MERCHANTS' Co., Baltimore.		DUBUQUE Co., Dubuque, Iowa.	
ize.	Pellets.	Size.	Pellets.	Size.	Pellets.	Size.	Pellets.	Size.	Pellets.	Size.	Pellets.	Size.	Pellets.	Size.	Pellets.	Size.	Pellets.
F	22	FF	24	—	24	TTT	24	000	29	—	—	—	—	—	—	—	—
T	36	F	27	—	27	TTT	27	00	32	—	—	000	27	TTT	22	000	27
T	41	VY	31	TT	32	TT	32	0	40	—	—	00	33	TTT	26	00	33
BBB	48	T	36	T	38	T	38	BBB	46	—	—	0	38	T	30	0	38
BB	55	BBB	42	BBB	44	BBB	44	BB	53	BBB	46	BBB	46	BBB	34	BBB	46
B	63	BB	50	BB	49	BB	49	B	63	BB	55	BB	53	BB	39	BB	53
I	80	B	59	B	58	B	58	—	—	B	68	B	62	B	52	B	62
2	90	I	69	I	69	I	69	I	79	I	79	I	75	I	60	I	75
3	118	2	82	2	82	2	82	2	98	2	89	2	92	2	77	2	92
4	130	3	106	3	98	3	98	3	116	3	118	3	118	3	77	3	118
5	182	4	132	4	121	4	121	4	163	4	134	4	146	4	94	4	146
6	245	5	168	5	149	5	166	5	181	5	170	5	172	5	115	5	172
7	305	6	218	6	209	6	209	6	252	6	215	6	246	6	140	6	246
8	426	7	291	7	278	7	278	7	306	7	303	7	323	7	180	7	246
9	615	8	399	8	375	8	375	8	426	8	420	8	434	8	225	8	323
10	950	9	568	9	560	9	560	9	584	9	592	9	596	9	365	9	434
11	1660	10	848	10	822	10	822	10	981	10	874	10	854	10	610	10	596
12	3316	11	1346	11	982	11	982	11	1003	11	1404	11	1414	11	1130	11	854
Dust	5910	12	2326	12	1778	12	1778	12	2305	12	2030	12	2400	12	3200	12	1414
—	—	—	—	—	—	—	—	—	—	—	—	—	—	—	12200	—	2400

CARTRIDGE-CASES.

The cartridge used to-day is still the same in principle as Mr. Daw introduced over thirty years ago, the sizes being identical. The ordinary 12-bore cartridge case is correctly $2\frac{9}{16}$ in. long, but much confusion results from this case being called sometimes $2\frac{5}{8}$ in. and sometimes $2\frac{1}{2}$ in. Other sizes, from 10 to 20-bore, are made this same length.

There is some difference in the shape of the anvil. All the best English and Continental makers adopt the plan of a movable anvil, but American makers use caps, which fit upon an anvil formed in the base of the cartridge-case, or a small anvil is used which is contained within the cap. The metal of American caps is thinner and softer than that used in England, the object being to have a more sensitive and easily-exploded cap. The drawback to this is that the striker frequently perforates the cap, and a large escape of gas results, and occasionally a dangerous escape, sometimes splitting the stocks of hammerless guns and blowing out the strikers of hammer guns.

Very fine cartridge-cases, as the "Ejector" case of Messrs. Eley Bros., and "The Grouse" case of Messrs. Kynoch, are covered with thin brass nearly the whole length of the case, following a principle adopted some dozen or more years ago by M. Bachman in the "High Life" case; for wet weather they are perfect.

The chief requisites in cartridge-cases for shot-guns are: perfect ignition, uniformity of size, capability of resisting atmospheric changes, and moderate pressure.

Nothing is more tantalising to the sportsman than miss-fires; hang-fires, too, are a great nuisance. To enjoy shooting there must be perfect freedom from tight-fitting cartridge-cases, and the cases must be well made to stand heavy charges and extract freely. Not unfrequently with cheap cases the heads are pulled off by the extractor, the cylinder being left in the chamber to be removed by the *grip extractor*, sold by gun-makers for this purpose, or cut out with the shooter's knife.

The cases must be of exact size also in the rim; many have small rims, so that in loading they may be pushed past the extractor, if force is used. Care should be taken not to do this; if the cartridge is put against the extractor and the gun closed, after the cartridge is fired the base will expand, and it will extract properly. It is also of importance that the case be substantially made, capable of resisting such pressure as careless packing in the magazine, or the usual accidents of travel may occasion. A stout well-made case will keep the powder in better condition than will a thin unglazed imperfectly-finished one.

Good cases are made by all the leading makers. Since the introduction of nitro-compounds distinctive colours are used, and the old line of colour

as denoting quality is not so strictly observed. The brown colour is still used for cheap cases.

For perfect ignition, few makers equal, and none surpass, the best cases of Messrs. Eley Bros.; the average of miss-fires through faulty caps is in their best cases only a small fraction of 1 per cent.

Their new case for nitro-compounds has a metallic capsule covering outside the paper like the old "High Life" cases, common on the Continent a dozen years ago.

The thin brass perfect case of Messrs. Kynoch has greater capacity than the paper cases of the same nominal gauge. These cases do not swell, and keep the powder in good condition. They are much favoured by some sportsmen; others do not like the "feel" of the sharp edges of the metallic cases, and continue to use paper. The latest pattern of perfect case has the base filled with paper pulp, which strengthens the rim, renders the base solid, and lessens the liability to miss-fire. These cases do not give way in the least; and if the primers are kept of uniform good quality, sportsmen may congratulate themselves upon having a truly "perfect" case. In America good paper cases, or "shells," are dearer than in England, and not equal in quality to those made here. The American metallic cases are good, but very dear. On the Continent a very cheap paper case—colour greyish-brown—is sold, which is of such poor

quality that all sportsmen would do well to avoid using them.

IGNITION.

Different makes of cartridge-cases, being furnished with different caps, are not alike in the method of ignition, of the explosion, nor in the time occupied in igniting the powder.

The time actually passed between the pulling of the trigger of a good C. F. 12-bore gun and the exit of the shot from the muzzle of the gun should not exceed $\cdot 0075$ of a second ; with the " Life " cases this is reduced to $\cdot 0065$ of a second, and if quick powder, as " basket " or No. 3, is used, it is again reduced to $\cdot 0060$ of a second or less. With smaller bores the time is less. When the time taken is $\cdot 03$ of a second or more, a " hang fire " is perceptible ; when $\cdot 06$ of a second, a click is heard between the pulling of the trigger and the report.

The original *Sporting Life* cartridge, introduced by the author some years ago, had a stronger cap, with respect to the quality and amount of fulminate used, than the other cartridges in use, and was the only cartridge perfectly adapted for nitro explosives.

The cartridge-makers now supply cases with strong caps, which offer similar advantages.

The difference in the form of anvil and the ignitions of the caps may be estimated from the accompanying illustrations.

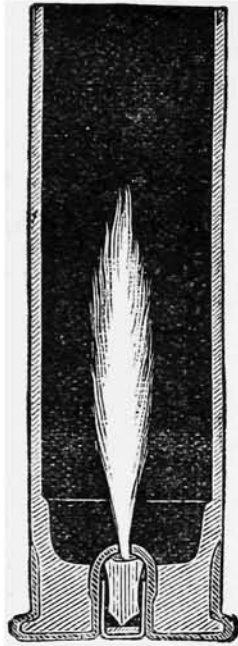

Sporting Life E.B. Case.

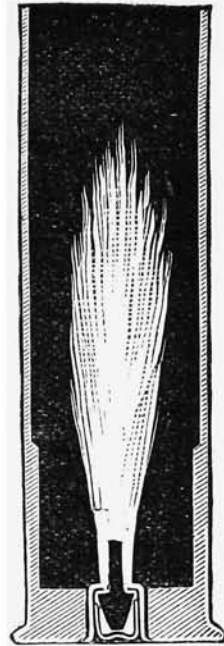

Original "Life" Case.

Ignition of Central-fire Cases.

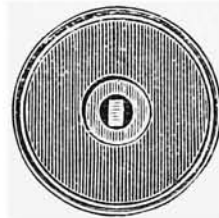
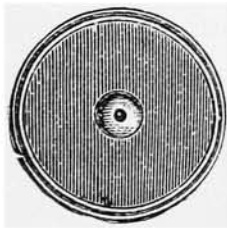

View of the Cap-chambers and Section of Caps and Anvils of the "Life" and "Eley" Cases.

The *Sporting Life* cases have given every satisfaction, and have attained a high reputation for killing power; many sportsmen will use no others, as they declare that they will kill game as no other cartridges can. These cases, when loaded with first quality powder, good wads, and chilled shot, make a cartridge far superior to any other in the market.

WADDING.

The wadding used in the shot-gun is of three varieties: 1st, the simple cardboard wad; 2nd, a felt wad; 3rd, a hard felt paper-faced wad, known

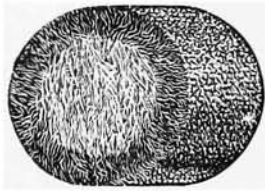

Felt Wad.

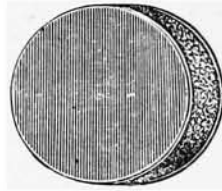

Field Wad.

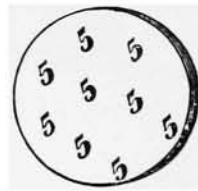

Shot Wad.

as the "pink edge" or the Field wad. A cardboard or waterproof (pitch paper) wad must be placed over the powder; this must be followed by a lubricating felt wad, usually $\frac{3}{8}$ ths of an inch in thickness. The top wad over the shot must be of the thinnest cardboard. Pink-edged, pink-faced, "Field," and thick cardboard wads, cloth wads, and black wads, are used for special purposes, as specified in the section on cartridge loading.

The best felt wads are elastic, of a light pink colour, deeper at the greased edge. Cheaper qualities are of a deeper tint, and the commonest are brown in colour and not close in texture. The "Field" wad is black (pitched paper) on one face, pink paper on the other ; the edge is greased. Pink-edged wads are greased at the edge, and have paper faces of a light pink tint ; they should be of elastic felt.

Numerous wads have been invented to act as concentrators in confining the charge of shot in its flight, but for the most part they act but imperfectly even with cylinder guns, and are quite useless with choke-bores. Wads of hard brittle material, which will crumble to dust when the gun is fired, are sometimes used over shot, though the thin card wad is still employed generally.

Felt wadding *must* be used between the powder and shot, a wad $\frac{3}{16}$ inch thick is enough for a 28-bore, and $\frac{3}{4}$ inch would not be too thick for an 8-bore ; as there is not a wad so thick, a pink-edged wad must be used as well ; $\frac{3}{8}$ or $\frac{9}{16}$ is the correct thickness for a 12-bore wad.

Wads need not fit the case tightly. There is little doubt but that the wads are expanded in the cartridge case before the shot is started. The felt wad serves to clean the fouling in the barrel left from the firing of the previous charge. The blackened edges of the felt wad are not caused by the gases of the ignited explosive singeing the

wad, but the fouling in the barrel, which fouling also hardens the wad edge very materially. It is quite possible that this fouling is in some way beneficial to the gun barrel, as it acts as a lubricant for the shot, and it is well known that a shot barrel with a certain amount of fouling will throw the shot closer and harder than a dry, bright barrel.

TO LOAD CARTRIDGES.

To load quickly and accurately, place the cases to be loaded base down upon the table. Adjust the powder measure, put the powder into a basin, take up a full measure, strike it off level with the base of the case to be loaded, and pour it in the case carefully, holding the case over the basin. Having filled all the cases with powder, put in the first wad and press it squarely and firmly down; the succeeding powder wads may then be put in and rammed home together. The shot must be poured in through a tundish, and preferably counted with the "Greener Shot Counter," or weighed to measure, the top wad of thinnest card, and not too tight, the turning over firmly and evenly done.

Cartridge-cases do not pay to reload; it is false economy in England to reload paper cases or perfects—abroad it may be necessary to do so occasionally, but no case fires so well a second time. Paper and brass cases both quickly lose their elasticity if reloaded and fired time after

time, and in reloaded cases there will always be a greater percentage of miss-fires than in new ones. The de-capping must be done as soon after firing as convenient. New anvils will be required to some cases; and care must be taken that the cap and the anvil are both got well "home" in the cap chamber when re-capping, or miss-fires will certainly ensue.

Paper cartridges and brass may be kept over from one season to another without appreciable deterioration, provided they are stored in a dry, airy place, and at equable temperature of 50°. Powder, whether black, Schultze, or "E. C.," that has once become damp or sodden, can never be dried so as to recover its original strength. Some nitro-compounds may be over-dried and develop dangerous qualities, but with either the Schultze or "E. C." powders it is not probable that such will result with even the most careless storing. It must not be supposed that the powder in damp cartridges can be dried without unloading the cartridges; to attempt to do so would be like trying to dry one's stockings without taking off one's wet boots.

THE "GREENER" SHOT COUNTER.

Further particulars of the "Greener" Shot Counter" have been so frequently demanded, that the adjoined illustration and description of this simple contrivance will doubtless be welcomed by

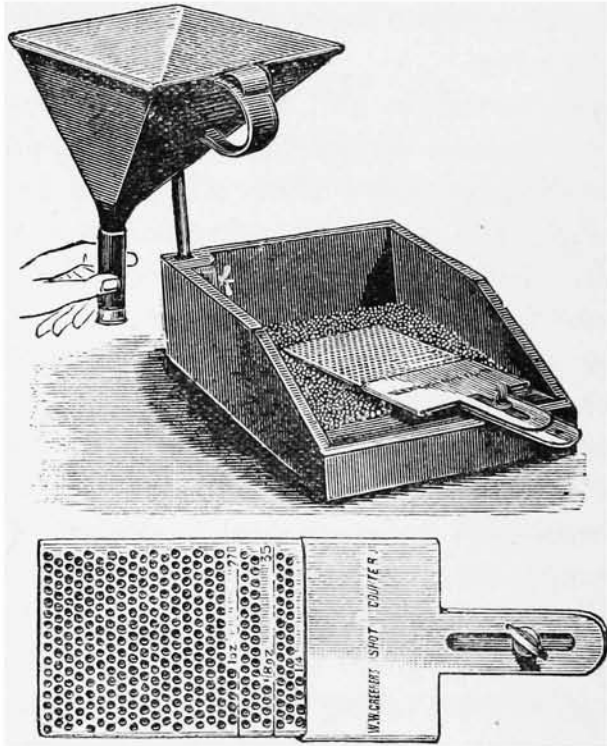

The Shot Counter, Shot Trough, and Tundish.

those cartridge-loaders to whom the machine is still unknown.

By drilling holes of the requisite size and depth in a sheet of hard brass, a species of trowel is formed, in which the pellets of shot will stick when the trowel is forced into a mass of shot and slowly withdrawn. For the use of sportsmen a pattern is now made with a sliding cover, by which the number of holes exposed in the trowel may be varied, according to the charge of shot it is wished to load into the cartridge.

As already stated, the charge of shot is in this manner regulated by *number*—270 pellets of No. 6 weigh one ounce, 304 holes for 304 pellets are allowed for the $1\frac{1}{8}$ oz., or standard charge, and beyond this charge the graduation may be varied with the greatest nicety.

In order to obtain exact results it is absolutely necessary that the *same number* of pellets are loaded into the cartridges; if the number varies—although the weight of the charge may not—there will be a variation in the pattern, which will probably prove misleading, and as it is easily avoided by using the counting trowel, the weighing of charges of shot should be discontinued.

The use of the trowel, with a plentiful supply of shot and the specially-made square—or ribbed—tundish, enables anyone to load cartridges accurately with great speed and ease, and it is a method far in advance of any system of weighing or measuring

shot charges. A glance at the trowel as it is withdrawn filled from the shot-box will show whether any undersized or misshapen pellet is on the trowel, any irregularity in size, shape, or number of the pellets being instantly discernible, as each pellet occupies a separate cell and is seen distinctly.

The price, with box, tundish, and stand, is so trifling—viz., 21s.—that everyone who loads cartridges should give this method of loading a trial. It will be found satisfactory, and a properly-made trowel will load millions of cartridges before the holes become so worn that it has to be discarded.

The author uses this counting trowel in loading all his cartridges, and has done so for many years. Sportsmen who do not load their own cartridges should see that the maker with whom he deals counts the pellets of the charge into the cartridges or states the number of pellets to the ounce used.

GUN-CASES AND IMPLEMENTS.

The gun that is worth owning is worth preserving. If kept in a gun-rack, or, better still, a dust-proof gun-cupboard, it will last longer, and if put away clean will always be ready for use. To take guns from place to place a case is necessary; if they are to be sent, a substantial oak case, leather-covered, is the best—such a case, well made, is worth about £5. It affords complete protection

to the gun, and will itself withstand the roughest usage.

Sole-leather cases—that is to say, cases in which best leather is *sewn* to pine frames—are light and handy, and do well to carry guns in, but they must not be used as packing-cases; and although they will upon occasion stand several trips to the Rocky Mountains, they are not adapted to the rough usage they receive in the goods-van, and do not protect the gun as will the oak-covered case. A best sole-leather case is worth £4. The leather-leg-of-mutton case affected by trap shooters is very light, and serves well to carry the gun; the cost is £2 to £3. Cheap soft canvas cases of the same shape are used largely in America, but they are not to be recommended, as the barrel is liable to injury and the trigger guard bent by coming in contact with each other. A case to carry the gun at full length has been recommended, but its bulk makes it inconvenient in many situations where the shorter case is no encumbrance.

It is preferable to carry cartridges in a separate magazine than in a tray in the gun-cases. These magazines are made to carry 50—the neat little case carried by the trap-shooter—and 100, 200, 300, 400, or 500, the last a substantial trunk, heavily made, and able to withstand luggage-porters' careless handling.

The divisions are preferable as in the English magazine, for the cartridges then travel better, and

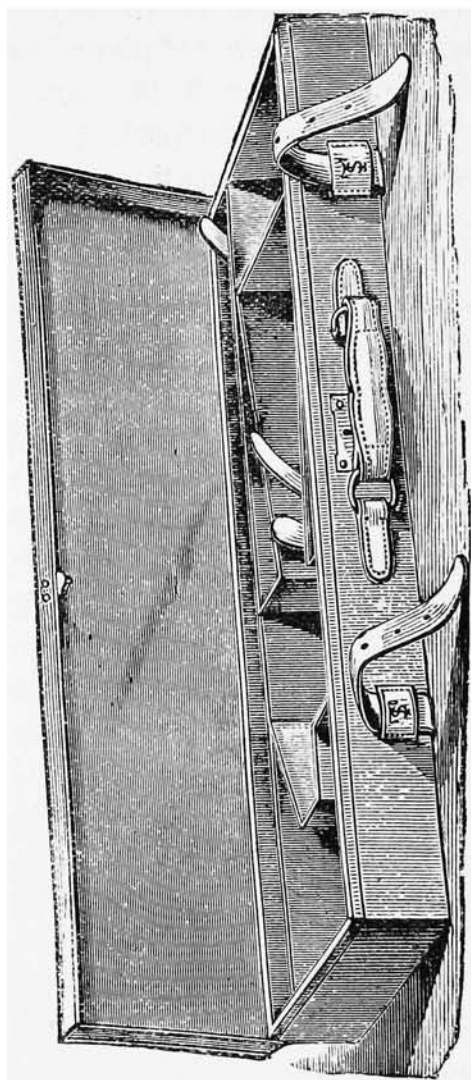

The English Gun-Case.

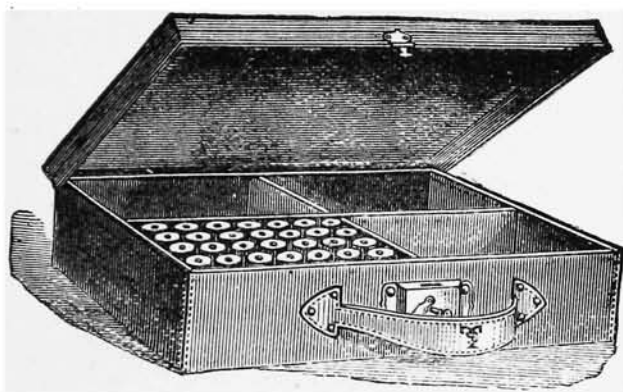

American Cartridge Magazine.

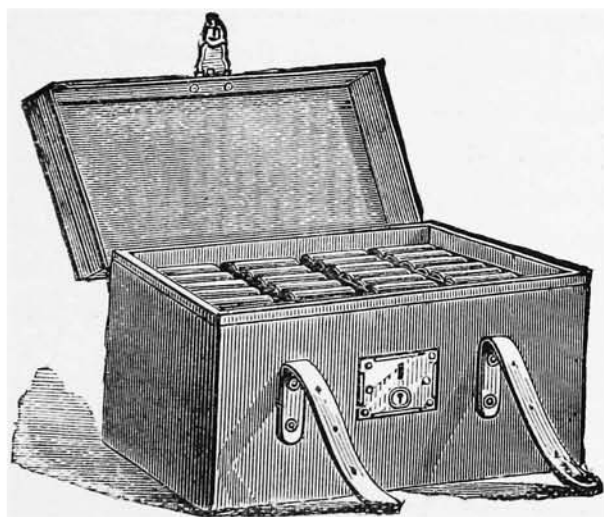

English Cartridge Magazine.

are more easily packed into and removed from the magazine.

The impedimenta in England may be restricted to a full set of cleaning implements, including pocket cleaner and chamber brushes, action brush, tow, rag, flannel, and oil. A pocket extractor is useful, and a pair of turnscrews may be kept in the cases.

Cartridge-loading apparatus will be found useless in England, where ammunition is cheap and it is not the rule to reload cases.

When travelling abroad, powder and shot measures should be taken, also a rammer and turn-over de- and re-capper.

Cartridges are best carried in a magazine of solid leather, or wood canvas covered. In the field cartridges may be carried in the pocket. Cartridge belts cannot be recommended for ordinary shooting, although there are times when they are very useful, if not indispensable. Cartridge bags to hold 75 or 100 cartridges are large enough for all purposes, and will be found to hang very heavily if much walking is done. Two small bags feel much lighter than one large one.

THE WEIGHT OF TRIGGER PULLS.

To test the weight of the trigger pulls it is necessary to pull them with the spring balance, each trigger at a different angle, as shown in the illustration.

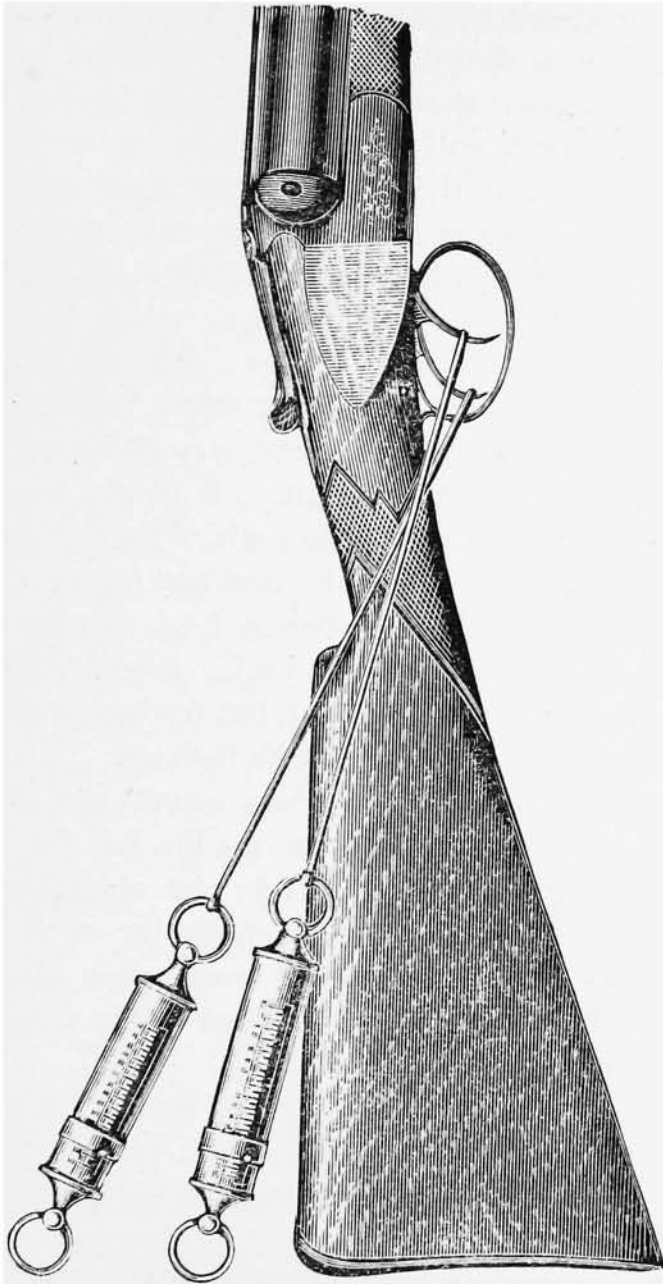

How to Test the Weight of the Trigger Pulls.

When a spring balance is not procurable, a dead weight, such as shot in a small bag, attached to the trigger by a piece of string, and the gun held at the angle, as shown, will answer equally as well. It will be seen that the angle in the illustration of the spring balance is different for each trigger; if the balance were pulled straight back instead of at the shown angles, the pull would be much heavier, especially with the left trigger. As the angles given are similar to the action when pulling the trigger with the finger, it is necessary to know this when trying the pulls of guns; it is the way in which all gun-makers test the pulls of their guns.

The usual pull off for fine game and pigeon guns preferred by English sportsmen is 4 lbs. for the right and 5 lbs. for the left lock. Light 20-bore guns will do about 1 lb. lighter, but for heavy duck-guns and rifles the pulls must be heavier.

Some Continental sportsmen cannot use a gun which has a pull heavier than 3 lbs. for the first and 4 lbs. for the second barrel; the objection to such light pulls is, they are likely to jar off if the gun receives a slight blow, or even when closing the gun after loading, if it is done rather sharply as it is sometimes.

The practice of slamming the gun up is dangerous, and young sportsmen should be very careful to close the gun after loading as gently as possible.

Some sportsmen prefer heavy pulls. Mr. Ful-

ford, the pigeon shot, always has the pulls of both his triggers 10 lbs. This weight is the heaviest the author has ever made for the ordinary 12-bore gun.

Gentlemen abroad, when ordering guns, should state exactly what weight the trigger pulls are desired, so that the maker may regulate them properly. It very often happens that fine hammerless and ejector guns are spoiled by jobbing gunsmiths in attempting to alter the pulls; it would be far better to go on using the gun as it comes from the maker, and get accustomed to the pull, than trust it with such men. The author has had several ejector guns returned from abroad which have been spoiled in this way.

It would be only a simple matter for the maker of the gun to alter the pull properly. The author considers that if a gun requires any alteration or repairs the maker of it is the proper person to do it, as he is more interested in seeing that it is done thoroughly.



CHAPTER VII.

THE GUN : HOW TO USE IT.

SHOULD a man carry a gun in such a manner as to endanger his companions he will be shunned by sportsmen generally, and quite deservedly.

Sportsmen who have been allowed the use of a gun from their boyhood generally make the best and most careful shots, therefore the earlier a boy is entrusted with a gun the more likely is he to make a safe shot. The boy who shoots, or is learning to shoot, is the one who most rarely fools with firearms. The maxim that "familiarity breeds contempt" does not apply to the knowledge of weapons, for the person of the "didn't know it was loaded" order is usually someone who has had nothing to do with firearms in their proper place.

To point a gun at any person should in itself constitute a criminal offence, and all firearms must invariably be treated as if loaded; therefore in all drill, preliminary to going into the field, make a point of treating the weapon as loaded. With practice safe handling becomes habitual, and it must be habitual before any sportsman should venture to shoot in company. The man who knows in what direction the muzzle of his gun is directed may be puzzled if it is accidentally

discharged, he is rarely disconcerted, never flurried or alarmed.

This state of complete self-possession is acquired by the practice of always treating the gun as loaded. There is time for a shooter to consider if every shot he fires is aimed in a safe direction, this without interfering with the rapidity or accuracy of the aim, provided he has previously noted in which direction he may fire with safety.

The beginner should first practise the handling of an unloaded gun until he can bring it up sharply and well to cover any point at which he is looking. In shooting, as with other sports, ease of movement is the first requirement, and this is only attained by practice—drill.

To become proficient in the use of the gun it is advisable to handle a gun for a few minutes every day in the shooting season, and at least once a week in spring and summer.

For this drill it is best to take a good position such as that of a crack shot at the trap (*see illustration*)—the left foot should be slightly in advance, the knees straight, the body bent very slightly forward from the hips, the left shoulder brought well forward, which allows a longer reach with the left hand; the gun must be grasped firmly with the right hand, the forefinger on the trigger, the left hand must be got as far forward as will permit of the gun being quickly manipulated, the gun being held well across the body. The left hand



J. A. R. Elliott's Position at the Trap.

well forward gives a better command over the gun, especially with respect to its elevation, but if too far forward it retards a change of aim from left to right.

In taking a double rise from traps, or in making a right and left at game, it is advisable to swing the body with the gun, and change the position of the feet also. Thus, the shooter will be always in practically the same position with respect to the object at which he has to aim. The change of position can, with practice, be accomplished without any loss of time, and the advantages are important. There is greater certainty of aim, and the firing is easier than when the upper half of the body is swung round from the hips.

For marks use something distinctive. A red or black seal, on a white card, is as good as anything. These should be fixed at different heights, and if indoors two should be at least twelve feet apart, standing, as illustration. Look at one of the marks and bring the gun quickly to the shoulder, pressing it firmly into position in doing so. The muzzle of the barrels should cease their motion just under the mark at which you were looking. Put up the gun similarly to other marks, changing from left to right, and high to low, at irregular intervals, until convinced that when your gun is brought to the shoulder, it is directed automatically to the point above mentioned.

To pull the trigger so as not to change the aim,

let the forefinger be well bent, the first joint resting lightly on the trigger, the other joints being held free of the gun. The trigger must be pressed, not pulled, or the alignment of the gun may be altered thereby. Snapping off the gun with a fired case in the chamber will do the gun no injury, and will enable you to determine whether or not the pulling of the trigger affects your aim.

Next try a few shots in the open, either at a wall or shot-proof screen. If the mark is fairly in the centre of the group of shot, practice at moving objects may be commenced.

It is also good practice to walk up to a certain distance, and upon reaching it to raise the gun and fire immediately. When this can be done well, learn to fire the gun when on the march, or nearly so. That is to say, bring the gun to the shoulder at the same time that your left foot goes forward with your body into position. This can be practised until you can be certain of the mark without breaking your regular walk, except for the very instant of firing.

Practise until both barrels can be fired with accuracy, within three steps forward, that is, the steps in which the left foot is advanced.

The main point is to get a good, quick, correct aim, and to fire immediately the gun is to the shoulder. This does not mean that the gun is to be fired in a hurried or haphazard manner, but when the object is in range the gun must be raised and

fired. There must be no taking aim as with a rifle, nor must the firing be delayed after the gun is at the shoulder. The shooter who attempts to follow the object by swinging round the gun is a dangerous shot, as will be fully explained later, and cannot become an adept shot until he fires upon the first sight.

There must be no practice at birds or other animals not in motion. Practice at the target is preferable to this sort of shooting, as from it something can be learned.

HANDLING THE GUN IN THE FIELD.

Before treating of the art of wing-shooting and its acquirements, a few words on the carrying and use of the gun in the field will not be out of place. The safest method of carrying a loaded gun in the field is to place it, top rib down, on the right shoulder (*see* illustration). Other safe positions are:—Under the right arm, the muzzle straight to the front; across the breast, muzzle high, and well to the front; the muzzle raised, the left side of the stock against the right hip; at the “trail,” that is, grasped in the right hand, the arm at full length, and the gun horizontal.

When standing for driven birds take a position as recommended for trap-shooting, when expecting a shot at game in sight; when waiting, hold the gun in one of the above-mentioned positions, or take one of the positions illustrated, or vary them.



Position of Carrying a Gun on Shoulder.



Position of Carrying a Gun under Arm.

The gun should be carried at full-cock, and if hammerless, with the safety off. Under ordinary conditions, it is better to unload a breech-loader when getting over a fence, crawling through a gap, or jumping a ditch. Even with hammer-guns (most top levers will open at full-cock) it is easy enough to take out the cartridges and reload the gun. Changing the hammers from full to half-cock is a very dangerous practice, or manipulating the safety-bolt of the hammerless only lessens the risk, does not absolutely remove it.

We have seen a man fall in getting over a five-barred gate; luckily for us he had previously unloaded his gun. One may come to grief in getting over a sheep hurdle or at an iron fence; the simpler the obstacle the more careless one is apt to be.

Before putting a gun out of hand, as through a fence, gate, or over a wall, or handing it to another person—unload.

Wire fencing is a great nuisance to shooters, both hands are often required to negotiate it properly—unload the gun before attempting to cross it.

Loaded guns in boats and vehicles are an element of danger.

To load a gun, there are several safe positions which are also convenient. In closing the gun the barrels often swerve to the left. This is especially the case when tight-fitting cartridges are used, or



Position of rest while waiting for driven game. Keep muzzles well to front in direction of expected shot.

the gun is cocked by the act of closing the gun, and care must therefore be taken that the gun is not brought directly across the body. Let the left hand grasp the gun at long distance from the breech, it gives one greater power and facilitates both the opening and the closing of the gun. If an ejector is not used, two loaded cartridges may be taken up and held between the first and second, and second and third fingers of the right hand, whilst the fired cases are withdrawn by the thumb and forefinger of the same hand.

The proper position to load a breech-loader is with muzzles pointed to the earth, for it not unfrequently happens that in dry weather and when using black gunpowder, flakes of the fouling will fall down into the breech action, when the barrels are higher than the breech, upon the gun being opened. The fouling, by lying in the angle of the action, prevents the gun from closing perfectly; this is often very annoying to the shooter who, seeing that the bolts or the lever do not snap home, imagines the gun is broken; or if he be careless and fire the gun in such a state it may allow the breech action to be blown open, being but imperfectly bolted, and thereby result in a serious accident to the user and his companions.

To load a muzzle-loading gun, place the butt on the ground, or on your foot, and incline the muzzle well outwards. When you have to load one barrel only, let the loaded barrel be that



Position for Loading.

farthest away ; do not grasp the ramrod with the hand, but with the thumb and forefinger only ; both locks should be at half-cock when loading. Muzzle loading caps should fit the nipples accurately so as not to burst in putting on ; they may then be taken off easily, but are not likely to drop off ; if waterproofed and capsuled, no fulminate is likely to adhere to the head of the nipple and cause an accidental discharge.

In all cases, the finger should not touch the trigger until the gun is in the act of being raised to the shoulder. Hammers should never be left resting on a cap or striker when the gun is loaded ; let the hammers be carried at full-cock. Look through the barrels before loading the first time after creeping through a fence, and after putting the gun out of hand for any purpose. If one barrel is fired repeatedly without discharging the other, it is advisable to take out the unfired cartridge occasionally, and ascertain whether the top wad has moved, or place the same in barrel which is fired first. With thin brass cases the starting of the charge is more likely to occur than with paper cases having a proper turn-over.

THE ART OF WING SHOOTING.

Much is performed automatically by the muscles, and muscular sense, or intuition, varies in degree with different persons. The shooter must look at the bird or other moving object, and

depend upon his own muscles to correctly align the gun, just as a boy watching a cricket-ball will put his hand where he knows the ball will be at a given moment of time, and does not need to look at his hand.

The physiology of shooting was cleverly stated by Dr. W. J. Fleming in a letter to the *Field* of February 19th, 1887—a letter which, we regret, we have not space to reproduce in full, and can but summarise indifferently. It has been demonstrated by actual experiment that what is known as “personal error” in the observation of objects is an important factor in calculating time or distances; astronomers, for instance, need to allow for this “personal error” in recording the time of a star’s appearance at a given point. If two distinct lights are so placed that either may appear or disappear instantly, different observers vary in their ability to quickly determine which light is shown, and record it by the depression of a key; the time required varied from one-hundredth to six-hundredths of a second. If it is assumed that instead of light appearing a game bird is the object visible, it follows that before any person can aim his gun at it, at least one-hundredth of a second of time will elapse, whilst another person, equally quick in aligning his gun, will not be cognisant of the object seen until upwards of six-hundredths of a second have passed. Consequently it follows that the allowance which one person would rightly make in

order to hit the object would not be correct for another person ; for, taking the two extremes, the object may have moved but 6 inches before known as seen by one, and 3 feet before known as seen by the other.

Anyone with a rudimentary knowledge of optics knows that before seeing an object that is visible, several physiological processes are automatically performed by the organs of sight. Its position and its distance from the observer are estimated by the other processes, mainly by the adjustments his eyes require to make to see clearly, compared with previous experience. The principal adjustments are the amount of convergence of the two eyes required to bring their optical axis to a point at the object, and the amount of accommodation necessary to bring the image of the bird to a sharp focus in the retina. These adjustments are made by muscles both within and without the eye, and they inform of the amount by the muscular sense, that same sense which informs whether we have one ounce or a pound weight in our hands. The muscular sense may be trained ; it enables sportsmen to judge accurately of distances, as letter-sorters and others judge of weights to a nicety. As it is dependent upon previous experience, it does not follow that the sportsman who can tell whether a partridge is thirty or fifty yards distant will know as well as a sailor how many leagues distant is a vessel, or the letter-sorter estimate the

weight of a bullock. Muscular sense differs in quantity and quality with individuals, and is a matter for special training. The sportsman who wishes to become a good shot must observe carefully and practice constantly. The ability to shoot well is a special gift to some, and though it may be acquired by all, we can only indicate how the skilful use of the shot gun may be developed. A sportsman may be a first-rate shot, yet unable to explain how he has acquired an unerring aim; some attribute it to one style of aiming, others to a different method, so many discussions take place amongst sportsmen and experts as to the correct method of aligning the gun, and the advocates of the various styles of shooting in the sporting papers detail circumstantially the most opposite experiences.

HOLDING AHEAD.

It is not the intention of the author to enter into a long dissertation upon the various merits and disadvantages of "holding on" and "holding ahead." It must be confessed that the advocates of the last method have theoretically the best argument, as the following figures prove:—

The utmost speed at which game birds fly may be taken as forty miles per hour, which means that a bird flying across the shooter at that speed will have travelled about twelve inches before the quickest shooter can have brought his gun to

position and pulled the trigger. The following "delays" may be assumed as unavoidable :—

Time occupied in raising the gun, 3-100ths sec.

Time occupied in pulling trigger, 1-200ths sec.

Time occupied in igniting charge, 1-200ths sec.

Time occupied in shot travelling 40 yards, 14-100ths sec.

During which the bird will have travelled 10ft. 6in., or thereabouts, and to hit a mark 10ft. 6in. to the right or left of the mark aimed at, the muzzle of the barrel would require to be more than 3 inches to the right or left of the line of aim. As pointed out previously, if, instead of being able to pull the trigger in $\frac{1}{200}$ th of a second, the shooter needs $\frac{3}{100}$ ths of a second, the bird will have flown 16in. further than is stated above.

Even whilst the charge of shot, having left the muzzle, is on its way, sufficient time elapses for a fast-flying bird to travel a considerable distance ; for the first fifteen yards or so, it may be taken that for every yard the shot advances the bird travels 2 in. The shot does not maintain its high velocity, and, providing the bird does, we have at forty yards' range nearly 1in. fled in the time the shot advances 1ft., and at sixty yards 1 $\frac{1}{2}$ in. fled for every foot advance made by the shot.

Allowing $\frac{5}{100}$ ths of a second as the time necessary for performing the involuntary and voluntary actions of seeing the mark, determining to shoot, raising the gun and firing, and also the small fraction of time required for the ignition and com-

bustion of the powder and its passage through the barrel, we find that with the 12-bore and standard charge at fifteen yards' range, a bird flying at forty miles per hour will have traversed 5ft. 6in. before the shot reaches that range from the gun.

If 20 yards, then 6ft. 6in.

If 30 yards, then 8ft. 9in.

If 40 yards, then 11ft. 5in.

If 50 yards, then 14ft. 8in.

If 60 yards, then 19ft. 4in.

A great deal of difference is caused by the manner of bringing up the gun. Some sportsmen acquire the habit of bringing up the gun with a swing in the direction the mark is moving; others bring up the gun and follow the object, whilst the majority of good shots put up the gun and are supposed to jerk it ahead of the game, and fire it before the latter motion has ceased. Those who shoot with the gun on the swing, and intuitively increase the speed of the "swing" in the same action as the increase in speed of the mark, never require to "hold ahead." Those who hold on, by shooting promptly, prove the truth of the theory that it is necessary for the hand and eye to act in unison; whilst they who hold ahead, although agreeing that the hand must follow the eye, yet so shoot that the hand must point the gun in a different direction to the object on which the eye is fixed. If the hand can be entrusted to intuitively direct the gun to any required distance

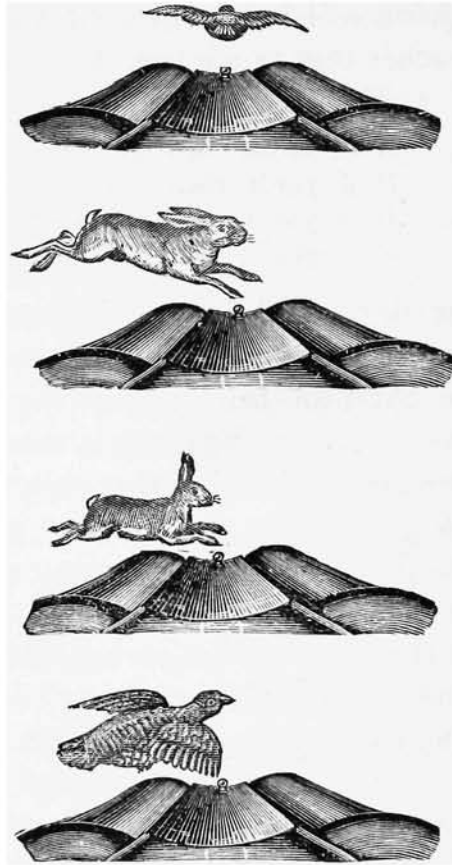

Showing the alignment of gun for various shots when practising the "hold on" principle.

above or before the object upon which the shooter's gaze is fixed, well and good ; perfect shooting will result.

The following hints as to aiming, etc., will be appreciated by all who have convinced themselves that they can, by practice, aim ahead of moving game :—

The young shooter, and all who desire to improve their shooting, should practise in the following manner : Commence by shooting at slow-flying birds, as pheasants (flushed, not driven), pigeons whose wings have been slightly clipped, or at rabbits frisking on the sward. Let all shots be at short range—twenty to thirty yards. When the bird gets up, the gun is to be brought quickly to the shoulder and fired whilst both eyes are looking at the bird.

Birds going straight away, and neither very high nor skimming low down, should all be killed, as the aim is the same as for a snap-shot at a fixed mark. Birds crossing may be missed, probably because the shooter fires behind them. By just how much the gun will be pointed ahead of the cross-flying birds may not be actually observed, but it must be known by the muscular sense, and if the shooter, whilst looking at a fixed object on a large wall or screen, consciously directs the gun (not aiming it by glancing down the rib with the right eye) to the right or left, he will quickly educate the muscles to direct the gun to any dis-

tances right or left of the object seen, and further practice will make him proficient in altering the elevation to any desired extent.

It is always necessary to keep the eyes steadily gazing upon the bird, and no attempt must be made to aim into space. Nor can any instructions as to aiming three, eight, or twenty feet ahead of moving objects be followed. My estimate of twenty feet may differ greatly from that of another, but practice at various ranges and previous experience of similar shots will direct me, as it will everyone who follows these instructions, to aim the gun intuitively in that direction where the charge of shot and the game simultaneously bisect—the one the line of flight, the other the line of fire, so long as the bird is seen.

When practising wing shooting there will be many misses, of course. After each miss the shooter should consider why the object was missed, and whatsoever cause may be assigned let him do his best to guard against it in the future; if a cross shot, and most probably he was behind the object, he must determine to direct his gun further forward when another similar shot presents itself. If he does this and continues to shoot without being hurried, flustered or disheartened, he will steadily improve in his shooting, but to go on missing, time after time, without giving a thought as to the cause, will do no good whatever.

When a bird rises, follow its exact course with

your eyes, and when it is in the best position for shooting bring up the gun from below or behind it, and if your hands act in perfect harmony with the eye and the will, as you have schooled them to do, the gun will be aligned instinctively, and immediately the object is in the position indicated in the illustrations well press the trigger. You may stop the gun at the moment of firing, you may not, it is immaterial, for your muscles, benefiting by their previous experience, will have performed for you, of their own accord, that order which you have not had time to think out or give them.

It is a good plan to continue the swing of the weapon whilst firing ; by so doing you send the charge of shot in the direction in which the gun is moving, but if you have acquired the habit of stopping the swing at the moment of firing and kill well, there is no need of changing the method. It is a mistake to bring up the gun so that it has to be lowered again in order to cover the object, or to bring it from before the object, though this latter plan is sometimes necessarily followed, as when the shooter facing No. 2 trap gets a quarterer to the left from No. 5, but ordinarily follow the flight of the bird if for the fraction of a second only, then bring up the gun and fire.

The allowances which will have to be made, as already explained, can only be determined by actual experience. The following general indications may, however, be of some service :—

The straight going away shot at birds should be point blank at any distance.

At ground game going straight away, shoot over the animal. Of approaching shot at birds shoot dead on, unless the bird is very high, when aim well in front. If high at long range and approaching, make less allowance, or wait until it can be shot at a pleasant angle nearer the shooter.

An approaching low shot, when a driven partridge or an "incomer" from the pigeon traps, aim under the bird rather than over it. Birds which cannot be shot as they approach, owing to the position of beaters, etc., must be allowed to pass over, and will furnish similar shots to those obtained by walking up to the birds, but their flight will probably be much quicker, and they will be higher. The bird must, therefore, be shot well under, *i.e.*, actually in front of it. A bird that has passed and flies low is a more difficult shot; the shooter must get ahead of it, and this is only to be done by shooting over it.

Birds crossing to the right are more difficult to hit than those crossing to the left. It is often advisable to move the position by turning one-quarter round on the right foot before raising the gun when there is a quick flyer to the right and you are shooting along or on the right extremity of a line. Longer shots may be made at crossing than at straightaway birds.

Some quartering shots are very easy, others most

difficult—it depends upon the speed and angle of the flight.

Ascending shots are difficult—the most if at short range, and flying quickly, shoot over the bird.

If the bird is well away and going straight or quartering, to get before it, *i.e.*, to hit, it will probably be necessary to aim below it.

Aim at the head of a pheasant rising; indeed, all game of which the head can be seen should be shot at as though the head, not the body, were the sportsman's mark.

Shoot at the head of all ground game. It often happens that incoming and motionless ground game is shot over, and neither hares nor rabbits should be shot at when more than forty yards distant. We have seen men fire at hares fully a quarter of a mile away and blame the gun!

The prettiest of shots and a difficult one to make is the perpendicular shot. In attempting this shot bring the left hand much nearer the breech than is usual for any firing at an angle of 45° or less and aim in front of the bird if approaching, and under it if going away.

Occasionally shots may be had at birds and hares descending, chiefly when shooting on the hillside, and these shots are difficult, the sportsman generally shooting over his game. Low flying wild-fowl, woodpigeons coming into lofty trees, hawks, crows, and vermin, generally afford different shooting practice, of which the sportsman will

profit. In order to become an expert shot, if other game is not readily available, starlings, fieldfare, larks, and even sparrows, may be used as marks, and much learned from shooting at them.

To practise systematically nothing is so handy as trap shooting, almost a separate art, but one which may be followed with beneficial results even by expert game shots.

OF HOLDING ON.

Snap-shooting and the "hold-on" principle of aiming is synonymous. We fail to see how anyone firing a snap-shot—as we understand it—can possibly hold ahead with any amount of certainty, for the space of time which the opportunity affords in many cases is only sufficient to take in the situation, and fire, it will not allow even for a mental calculation. We favour the "hold-on" and snap-shooting system for several reasons, chief of which are—it is prettier, safer, and in our opinion surer, and it offers, to say the least of it, many more chances of a full bag than the slower way of aiming. First, it will be admitted that the *style* is far better in snap-shooting than in the "hold ahead" practice; second, it is safer, in so far that there is no tendency to "poking," which the hold ahead and slow calculating shots lean to, even though a little—a little which with young shooters is likely to become more. It must be remembered that "the man who hesitates is lost"; hesitation in

firing, at any rate, means loss of game and perhaps everything else except experience to the shooter.

An instance of the danger of the "poking" aim once warned us of the dangers of the system even when practised by a sportsman and regular shooter of twenty-five years' standing who, on one occasion, allowed himself to be carried away by his excitement to the extent of "following up" a partridge at least three parts of a circle before firing. The bird rose on his left and flew low across his front quartering to the right until it had nearly completed the circle before it fell to the long-expected shot. The shooter had his gun to the shoulder the whole of the time the bird was on the wing, and in following up and trying to make the proper allowance his gun covered many of his companions, the beaters, and dogs, although, in the end, the bird only was shot; the attitude of the shooter appeared extremely ludicrous to the others of the party after the muzzles of the gun were directed towards a safe quarter. Third, very many more opportunities occur for a snap-shot and to one accustomed to take them than to one practising the slower methods.

For instance, when shooting cover, either in line, alone, or by beaters.

After reading those paragraphs in this chapter relating to the physiology of shooting and optics the reader will probably understand more of the reasons why we favour the "snap- or hold-on"

system ; it is, moreover, much easier to become proficient at this style than at the other, and therefore more easily learnt. We are not so much in favour of copying a good shot's style ; everyone is built differently and has different degrees of muscular sense, therefore everyone should find out for himself the method that suits him. To give one confidence there is only one necessity, and that is, that the shooter can rely on his gun coming up to the shoulder exactly to the same position every time.

OF POSITION IN SHOOTING AND THE ALIGNMENT OF THE GUN.

The accompanying illustrations show several positions in shooting and the proper alignment of the gun for game taking different directions of flight ; these will be found to be pretty nearly correct, and at any rate will serve as a basis upon which young shooters may begin. The illustrations in this chapter showing positions of the gun for different shots we hope will be some kind of a guide for the beginner as to the fit and handling of his gun. It will be seen that we hold to the old style of allowing the stock of the gun at the comb to lie against the cheek, by this one is able to tell that the gun is in exact position. If the shooter has good command over it he should fire the instant the stock touches his face ; by always adopting one position for the head, shoulders, body, and feet, with the touch of the stock on the

cheek as an indication for the time to fire, one will very soon make good progress in the art of snap-shooting.

Some quick shots, however, anticipate the time it takes to *fire* the gun and pull the trigger whilst raising the gun to the shoulder. This requires considerable practice to perfect, and the gun must, of course, be within an ace of the proper position ; but, however the practice may be deprecated, it is certainly *au fait* for trap- as well as general snap-shooting.

For high overhead shots it is not advisable to shoot at a greater angle than that shown in position (page 217) ; this is quite awkward enough, and even then the certainty of the alignment is not so effective, owing to the left hand having to be held nearer to the breech.

For cross-shots, although in theory the gun should be held ahead, in some cases as much as 7 ft. at forty yards, yet in practice we have found that in holding on to the head, as on page 206, was quite sufficient allowance to kill, though in many cross-shots at any angle not above 45 degrees the gun is always brought up from behind. It may be that the swing has the effect of throwing the muzzles more in that direction than intended by alignment. If the gun is fired before the motion is stayed the shot will, of course, fly in that direction in which the gun was swinging when the charge of shot left the muzzle.



Showing position for ordinary straight-away and rising shots.



Showing greatest angle at which overhead shots should be taken.

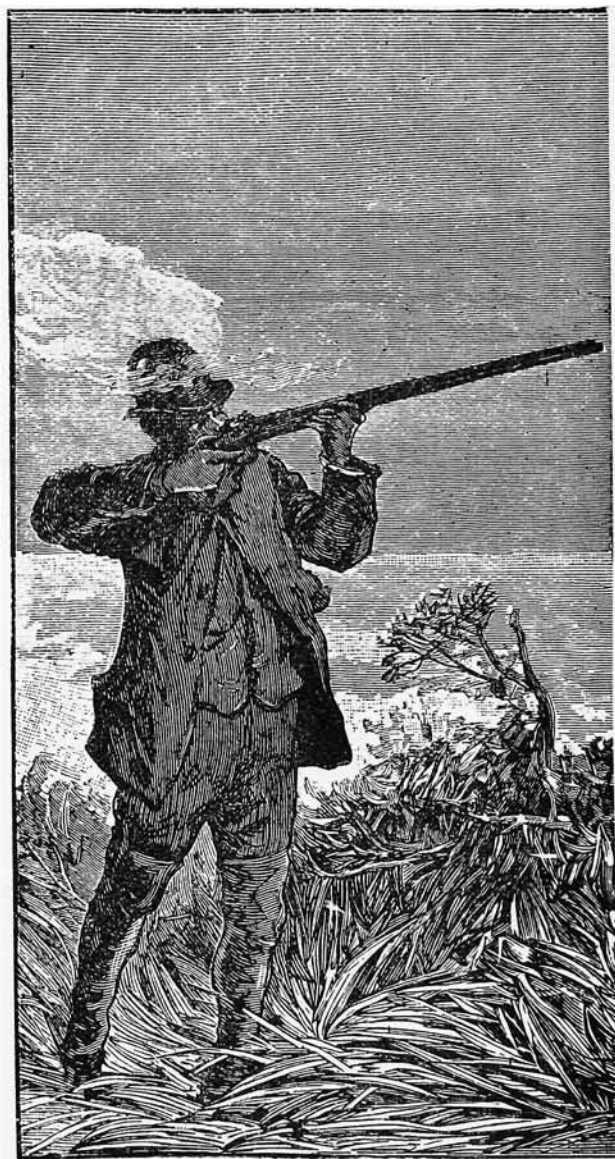

Bad position, not to be imitated.



The above position shows how the muzzles of the gun should be when firing; unless they are perfectly square, bad shooting will result with one barrel. The habit of getting the left barrel higher than the right must be guarded against; it is a frequent occurrence with some sportsmen just when pulling the trigger to give the gun a twist over to the right. By aiming at a mirror and pulling the trigger any fault of this kind will be easily detected.

CHAPTER VIII.

OF SHOOTING GENERALLY—THE ETIQUETTE OF FIELD AND COVER—HOW TO OBTAIN SPORT AND ENJOY IT—HOW TO FIND GAME—SHOOTING EXPENSES.

THE sportsmanlike use of the shot-gun implies much more than is included in good marksmanship.

The sportsman not only uses his gun, but must exercise his brains in order to use it properly. It is important to acquire an accurate judgment of distance in order to determine what is, and what is not, a sporting range at which to fire ; it is also advisable to observe carefully the result of each shot, and mark where the game was struck, this may save much time in retrieving wounded birds, but for the old-fashioned art of woodcraft there is little demand now, and good and safe marksmanship is considered a better qualification.

The modern style of shooting is the natural result of present day methods of agriculture. The scythe and reaping machine have succeeded the sickle, and the stubbles are now shorn so close that they do not afford cover to partridges, and when partridges resort to them, as they do, to feed, at certain hours of the day, it is generally quite im-

possible to approach within range either with or without dogs.

The sowing of root crops in rows has also spoiled the chance of the dogs in the turnips, the birds sneak out of the field as soon as the men and dogs enter it, as the game can see from one end of the field to the other, and cunningly escape unobserved. The sportsman who is determined to have some shooting, resorts to driving, by which means he accomplishes his purpose, and also makes the game much more wild.

The sportsman who is determined to shoot over dogs and hunt his game in the old-fashioned way will find full instructions in the many books on shooting which have been published, but will need considerable experience before becoming successful. The fact that changed conditions have greatly handicapped his chances, and have forced sportsmen to other methods, may not deter him from persevering in his method, and it is quite possible, with hard work and much cunning, to outmanœuvre a few coveys by what practically amounts to stalking them ; no one will grudge the sportsman whatever success he ultimately achieves.

The sportsman whose shoot is small and the game—not being hand-reared—scarce and wild, will be unable to practise driving to any advantage ; the best plan will be to walk up to the birds as afterwards described. The drive, or *battue* as it is more commonly called, is the best manner for a

proprietor or lessee to demonstrate the quantity of game upon the estate, and it is generally the only way of securing a fair proportion of it.

To organise a drive upon a fairly large scale the assistance of many men as beaters will be required; the plan is therefore only suited to a large party, and its management is a business requiring much knowledge, forethought, and preparation. The methods employed with the greatest chance of success are detailed in such a book as "Shooting" of the Badminton Series, to which we must refer the reader for further information as to the management, or what may be called the "engineering" of work of this kind. The host or other responsible director, if he does what is considered to be his duty to the shooters, will see very little of sport and will have an onerous task to perform.

As to the shooters, they will learn very little of woodcraft or of the habits and habitat of the game, but they may have ample opportunities for testing their skill as marksmen and of observing the peculiarities of the flight of frightened birds; and they may rightly enjoy the day's sport, in which they do not so much participate as—to use a Gallicism—assist.

The shooter called upon to take part in a day's sport of this kind will find, if partridges be the game sought, that the keepers or their assistants have, previous to the arrival of the guns, driven the

birds into a convenient field with sufficient cover to hold them, that is, with a growth which will hide the birds. The shooters are then posted behind a tall fence, barrier, or even artificial screens, which will conceal them; they should be such as, whilst hiding the shooters, will permit them to observe the flight of the birds when driven towards them.

The shooter should be informed of the location of the other shooters and the direction in which the beaters will advance, and then go at once to his stand and wait quietly and expectant until the warning "mark over" of the beaters informs him that birds are on the wing.

All alert then, he will, as soon as any bird comes within range and within his circuit, be ready to fire. In some positions he may be able to fire at the birds as they approach; in others he must wait until they have passed over. Frequently two shooters will be stationed together; it is usual for one to take birds on the left and the other birds on the right, a rule which must be loyally observed and to which the only exception is the firing at your companion's birds after he has fired both barrels and the birds are in range.

In partridge-driving the stations are frequently changed, and the object is to break up the coveys as early as possible in the day, marking the escaped birds down, and putting them up again and again in successive drives, so that often a covey from

which little is bagged in the morning will afford excellent sport later in the day.

Pheasant-driving is pursued, not so much for the sake of securing shots at the birds, as is the case with partridge-driving, but for the object of obtaining sporting shots.

The drive is, or should be, so managed that the birds are forced to rise at some distance from the shooters, and consequently approach at a good height, and flying faster than if put up as straggling birds in hedgerows or cover. Here, again, the shooter will be called upon to exercise his skill as a wing shot. There will be little walking—no hunting in the true sense—and the man who can keep cool, shoot deliberately, and observes the usual etiquette of the shooting-field, will probably enjoy good sport, unspoiled by blank covers or too wary birds.

Some guns are usually told off to walk up with the beaters. These do not, as a rule, get so much shooting as those posted in the line towards which the game is driven ; they see more of the working of the “ battue,” and require to be even more careful, both as to the direction in which they shoot and when to fire.

Grouse-driving has become very popular with all able to rent or subscribe to a moor. The guns are stationed in batteries, boxes, or shelters, especially constructed for the purpose. In Derbyshire they are occasionally posted behind the stone walls common to the country. Fifteen to twenty

beaters will drive, commencing a mile from the guns, and form a line, nearly half a mile in length beating towards the centre. Driven grouse fly at great speed, and afford excellent opportunities for a display of skilful markmanship.

The young shooter will do well to observe most punctiliously the written rules and accepted conventionalities of the shooting-field. Smartness of manner is considered very bad form. A young man is not supposed to be an unerring shot, nor expected to tell good stories. If a shooting companion, older than yourself, and a shot of established reputation, fires both barrels at a bird, and misses, it is better to let the bird go, even though within range, than "drop" it, to your companion's mortification. You have life before you, and may get other opportunities. Don't shoot to wound game, but to kill it. If a wounded bird struggles in front of you from a companion's gun, drop it if you can. Explain to the first shooter that you did so to save time in gathering it, or remark, simply, "Yours."

The compilers of books of instructions to young shooters deem it necessary to advise beginners against calling attention to the clever shots they make. It has never been the writer's luck to meet with young sportsmen guilty of this practice; they are prone to remark "clever shot," or "that was well done," when someone else has brought down a difficult bird, when perhaps absolute

silence would have been preferable. They will talk of their performances at other times, and so unfortunately will older men, who ought to know better.

In order to stand well in with shooting companions, and your host, or his keepers, avoid risky shots, make yourself well acquainted with your gun's power, and shoot at nothing not well within its range, and do not bang away at game too close. Learn to judge distances accurately, and you will make few mistakes on this score. Give fair play to the game, and to your fellow-shooters, and if a man near you is getting more shooting than he can manage, whilst you have none, it is his place to call you to help him, not yours to edge up to him. Think of this when you have more than your full share of luck.

When walking in line up to birds, or with the beaters in covert, mind and keep to that line. It is dangerous to you and your companions to be either ahead or behind it.

When shooting with one friend, take the birds in the covey nearest to you, and ground game directly before you.

To fire at low birds and ground game in covert is frequently very dangerous. In the same way low birds coming towards you from the line of beaters must not be shot at unless you know that the beaters are well beyond the range of your gun.

Do not fire at anything you imagine to be a

rabbit moving in covert, this is the way dogs, foxes, and sometimes beaters, get shot.

Do not waste your time and that of your companions by insisting upon a bird you *thought* you saw fall being retrieved.

When shooting alone, or over dogs, the sportsman has greater latitude as to what, when, where, and how to shoot.

The shooting of grouse over dogs is fully treated in all old sporting works and several modern ones. The well-known authority upon sporting dogs, "H. H.," will probably republish a book from the excellent series of articles now appearing in a sporting paper. If these should not be procurable, the sportsman in want of information may refer to Thornhill, Craven, or F. Speedy.

To get partridges, a small party will find it best to walk up to them. Dogs, except for retrieving, will be useless, and a keeper or beater or two to gather the birds, look after the dogs, and mark down the birds, will add greatly to the success and enjoyment of what is the finest of modern field sports followed in this country.

In the early morning the partridges are usually to be found feeding in the stubbles, and as it is next to useless to attempt to get within range of them there, it will save time if two or three men will walk the stubbles before the shooting is commenced, and thus send the birds to better cover.

A mixed line of shooters, beaters, and keepers

is then formed, and if game be plentiful it is advisable to have as many retrievers as there are shooters, as better speed will be made if beaters or keepers are not occupied in picking up, and can look after wounded and towering birds; a badly broken dog, will, however, prove the greatest nuisance which can be introduced into the party. The beaters should also mark as nearly as possible where each bird has fallen, and in this they can also be aided by the shooters; a mark from different positions on the base line of the triangle will frequently save a prolonged search by confirming accurately or rectifying an error in marking.

In turnips, partridges are always more easily approached if the party make their progress across the drills. If it is preferable to walk in a line with the drills in order to drive the partridges towards any other particular cover each man should change frequently a few steps to the right and left of the drill in his direct line.

When there is no object to be gained by driving the birds in any particular direction the line will wheel at the end of the field and take the next strip, otherwise the steps may be retraced over the ground already traversed, and the line re-formed so that the field may be worked uniformly in the one direction; as the field is worked to the finish the flank men of the line will advance so as to hem in any birds which may have moved to the extremity of the field and are unwilling to leave it.

A line, instead of being formed at right angles to the fence, may traverse it in *échelon*, *i.e.*, at an angle, a manœuvre often successful ; also, when the shooters may be relied upon to shoot carefully, instead of a straight line the party may form so that the shooters and beaters at the flanks will keep in advance of those in the centre. A line almost semicircular will sometimes prove effectual, or other modifications may be made to accomplish a particular object, but this can only be done with safety when one and all carry out the plan with mathematical exactness. When working the bowed line it is only fair to the shooters that in wheeling the pivot man is alternately at the right and left extremity of the line. If the line is re-formed each time the field is traversed the party should either cross over, equalising chances, or one half should do so, thus bringing the flank men to the centre and the centre men to the flank alternately.

In stalking partridges do not attempt to get near them in a direct line, but walk half round the covey, closing in gradually to the flushing point. If the party divide to the right and left, and carry out this manœuvre carefully, it is possible that the party flushing the covey will drive the escaping birds within range of the other division and thus increase the chances of securing the majority of the birds.

Late in the season, when the birds "pack," driving is the most effectual method of making a bag.

The use of kites is said to have the effect of driving the game to other ground, and should, therefore, be used rarely by proprietors. Lessors sometimes stipulate that kites shall not be used.

A shooting leased of farmers cannot be well preserved without great expense, and some farms are so badly situated that the game bred upon it frequents neighbouring lands in preference. Some lessors obtain high prices for shooting which it is almost impossible to work with satisfactory results. More game can sometimes be bagged from land the shooting rights of which are sold for sixpence an acre, than other ground in the same locality for which five times the price is obtained. The price paid for shooting bears no relation whatever to its value.

Where the shooting is small, a couple of hundred acres or so, and the land well farmed, it is advisable to stipulate that at least a few acres shall be sown with something that will afford suitable cover to the birds late in the season. Turnips, potatoes, clover, mustard, etc., are good ; but to hold the birds late in the season, if there is no natural cover on the shooting, a patch of buck-wheat will afford that protection and shelter the birds prefer ; grass, furze, fern, ample hedgerows, and some planted cover, will attract partridges, and in order to increase the stock the birds, except old cock-birds, should not be shot after December.

If an attempt is made to rear pheasants there

must be a "pheasantry," or suitable plantation on the shooting, and at least a couple of men to look after the birds ; a trouble when increasing the stock of pheasants on a small shooting is the greater relative expense compared with that of doing the work on a larger scale, and the difficulty of keeping the birds at home. To raise pheasants for your neighbours' shooting is often unavoidable, and if the covert frequented by pheasants is made more attractive by often placing tempting food there, a stock may be increased by birds from adjacent coverts ; barley, beans, malt, raisins, etc., are used for this purpose, and it is said that a few hundred of common gooseberry-bushes planted as under-wood makes a first-rate cover.

Hares are becoming scarce in this country, they are an easy shot even when driven with other game. They may be looked for on fallows, grass-land, and amongst turnips. In Scotland the Alpine hare, a different variety, is plentiful, and these hares are often driven, owing to the nature of the ground ; hitting them is more difficult than on a fallow field in the south.

The woodcock is, unfortunately, still more rarely found ; put up in thick cover and taking an irregular flight it is one of the most difficult birds to bag ; if shot at close to it will probably be missed, if the sportsman waits it will be lost sight of in the covert, its turn to right and left being most erratic and unexpected.

Rabbit shooting is the easiest shooting obtainable in this country, and there are very few people fond of shooting who cannot command, at least, a few days' sport of a friendly farmer or landowner.

Rabbit shooting, the most generally practised of sports with the shot-gun, is the most dangerous; firstly, because all the firing is done with the gun pointing towards the ground; and secondly, because the speed with which the rabbit bolts is provocative of random shooting. It is not uncommon for a rabbit to run between the shooter's legs and be shot within three yards of him by some reckless shooter on the alert for fur. In a warren or quarry a rabbit about to disappear over a ridge will be shot neatly just as the hat of a man on the other side becomes visible. When ferreting, it is quite impossible to keep men from getting into places where, for their own safety, they should not be. The young sportsman can more easily do irreparable damage when rabbiting than at any other sport, and must consequently use the utmost care to avoid accident. Always fire at the head of a rabbit, and to shoot safely in covert do not make a shot at where the rabbit will be, but shoot straight for him or not at all.

Another dangerous practice is the division of shooters by a substantial hedge with dogs working the hedgerows, the rabbits will run out and straight along the hedge and then run in again. It

is unadvisable to shoot towards the hedge under any pretence ; dangerous to do so unless you know exactly the position of the man, or men, on the other side of it.

If rabbits are put out properly and the shooters keep well back, good shots may be obtained when the rabbits make a run across the open for fresh cover.

The young shooter may ruin his prospects as a sportsman by a single indiscretion—the making of a risky or a dangerous shot ; he will not be an acceptable companion to shooting men unless he endeavours to kill his game in a sportsmanlike manner, avoiding the wounding of game, and not firing at quite impossible distances.

The man who may be relied upon as safe to shoot with under every condition, and who, in addition, is better pleased by killing a few birds in a clean and sportsmanlike manner than in making a heavy bag, will have opportunities for obtaining sport denied, on principle, to others.

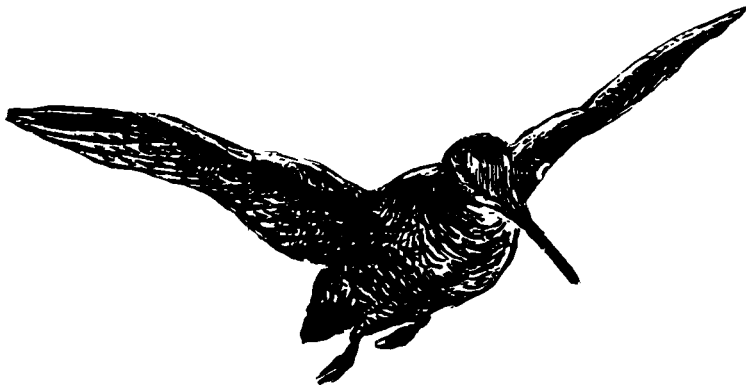

CHAPTER IX.

PIGEONS AND TRAPS—BOUNDARIES—RULES—
MODIFICATIONS—RECORD MATCHES—HINTS ON
LIVE BIRD SHOOTING—INANIMATE TARGETS—
RULES—BEST SCORES—HOW EXPERTS SHOOT
—GUN TRIALS—LONG SHOTS—GROUSE DRIV-
ING, BY SIR F. A. MILBANK.

TRAP SHOOTING.

PIGEON shooting, against the practice of which many sportsmen protest, unlike British field sports, is of lowly origin, but for several generations it has been a popular pastime with many of the best known sportsmen of this country and is practised fairly and legitimately in all parts of the world. At all respectable clubs there is no cruel treatment of the birds and fair play is accorded to every shooter. Pigeon shooting has long been a holiday pastime with the frequenters of low public-houses, and has been and still is used as a means by sharpers to fleece the unwary young sportsman. It is wise to shoot pigeons at recognised clubs only, whether in England or elsewhere ; and before accepting an invitation to shoot a friendly match, to make sure of the character of the person who invites the contest, or experience at the trap may be very dearly bought.

Pigeon shooting as a sport may be said to date

from about the middle of this century, although there were occasional matches and contests earlier. The first handicap is said to have been shot upon Mr. Purdey's grounds at Willesden in 1856, but previous to this there had been fashionable contests at the "Old Hats" public-house, on the Uxbridge Road at Ealing, near London. The "Old Hats" obtained its name from the fact that the pigeons used for the matches were placed in holes in the ground, and were covered with old hats. The "Red House" at Battersea was afterwards the favourite metropolitan resort for wager shooting. The first *bonâ-fide* pigeon club was formed at "Hornsey Wood House." Traps were used here, and the "small cannon" which were formerly in vogue as pigeon guns were discountenanced, and the ordinary double-barrelled fowling-piece substituted.

PIGEONS AND TRAPS.

The pigeon generally employed for trap purposes is known as the Blue Rock. The best variety, the Lincolnshire Tin Blue Rock, retain the wild nature of the common blue Coast Pigeon. They are fed in Lincolnshire by the farmers in winter time, who also raise cotes for them at a good distance from their other buildings, as the wilder the birds and the nearer the coast they are raised the stronger and more hardy they are. The true Tin Blue Rocks afford the best sport, and are much the hardest to kill, being small in the body, quick in flight at

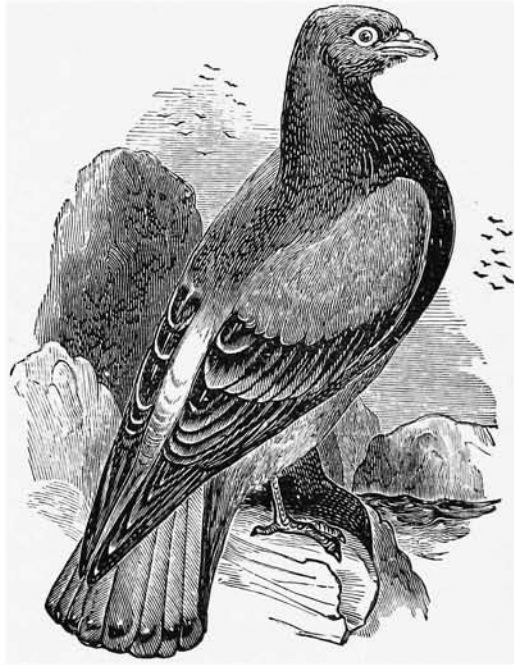

The Coast Pigeon (Blue Rock).

starting, tough in their nature, and game to the death, especially the hens.

Other Blue Rocks are bred in Oxfordshire and Yorkshire in large quantities, but are inferior to the Lincoln birds.

Many of the so-called Blue Rocks are also imported from Antwerp; in fact, the greater portion of the pigeons used for trap shooting are brought over from that port, and sold here as Tin Rocks. Some years ago a number of Tin Rocks were exported to France and Belgium for breeding purposes, and their offspring is now imported; the foreign climate has not improved them, as they possess little of the gameness peculiar to the English bird.

The real Rock is not always of the same marking; there are light and speckled Rocks.

Pigeons intended for trap shooting should not be used to being handled, and at the principal clubs several stringent rules are in force against any ill-treatment or mutilation of the birds. The purveyor to the club should find it to his interest to supply the best, that is the strongest, healthiest birds, and the trapper should be the servant of the purveyor, so that it is to his interest that the birds fly strongly. The hampers used should be spacious and well ventilated and a proper place should be provided for them under shelter or in the shade. The retrieved birds should be placed on or near the hampers containing the living pigeons. The

purveyor should provide good dogs for retrieving. The puller should be a club servant.

Then if the ground be properly laid out and arranged and the standard rules adhered to, any collusion as to the trapping of weak birds may be prevented and any form of dishonesty, except the wilful missing of birds, may be guarded against.

The pulling apparatus should be of the very best. Buss' is a very good one; that used at Monte Carlo and the Hurlingham pulling apparatus is also good. The traps must not be too small and should work smoothly, being flush with the ground when pulled over. The cords or wires to operate them should be underground.

PIGEON-SHOOTING BOUNDARIES.

Boundaries vary to 20 yards. The Hurlingham boundary is 90 yards from the centre trap, and the enclosure fence 8ft. high. The Gun Club boundary is 65 yards and the fence 9ft. The Monaco boundary is 17 metres (about $18\frac{1}{2}$ yards) and the fence only 3ft. 4in. high.

An ideal ground would have a fence about 8ft. high at least, with reserved ground outside this fence that wounded birds may be readily recovered. At Monaco and Paris the birds fall into the water.

The handicap distances should be available from 81 to 35 yards from the centre trap; the puller should be at or near the 30 yards firing point.

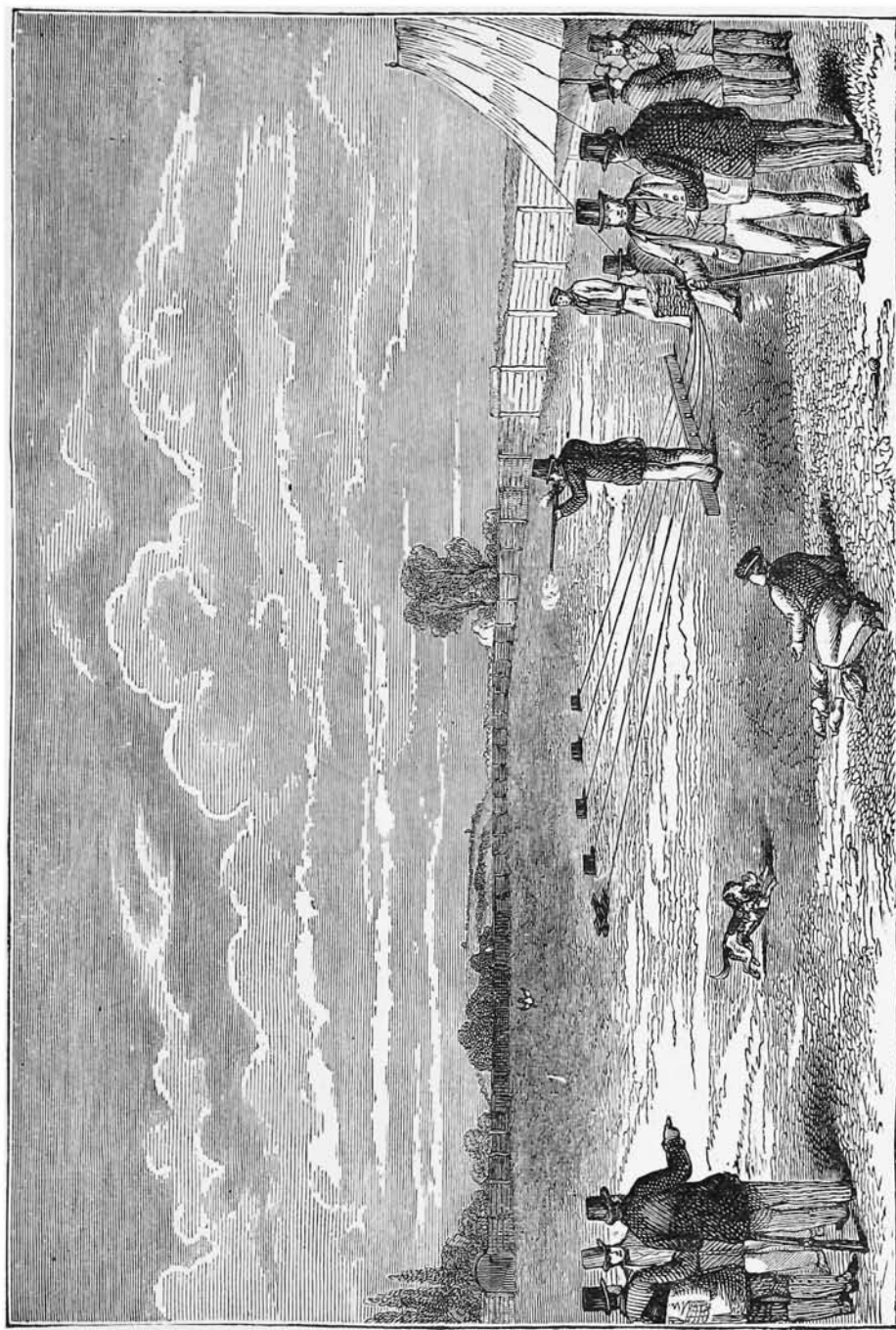

Figure 11 Shooting at Hornsey Wood.

RULES OF LIVE BIRD SHOOTING.

In England, as well as in America, the English Colonies, and in most clubs founded upon the same basis as our English clubs, the Hurlingham Rules are accepted without important modifications. At the Gun Club, and at Hurlingham, the weight of the gun is now unlimited.

THE HURLINGHAM CLUB RULES.

1. The referee's decision shall be final.
2. The gun must not be held to the shoulder until the shooter has called "Pull." The gun must be clear below the armpit, otherwise the referee shall declare no bird.
3. A miss-fire is no shot under any circumstances.
4. If the shooter's gun miss fire with the first barrel, and he use the second and miss, the bird is to be scored lost.
5. If the miss-fire occurs with the second barrel, the shooter having failed to kill with his first, he may claim another bird ; but he must fire off the first barrel with a cap on, and a full charge of powder, before firing the second.
6. The shooter's feet shall be behind the shooting mark until after his gun is discharged. If, in the opinion of the referee, the shooter is balked by any antagonist or looker-on, or by the trapper, whether by accident or otherwise, he may be allowed another bird.
7. The shooter, when he is at his mark ready to shoot, shall give the caution "Are you ready?" to the puller, and then call "Pull." Should the trap be pulled without the word being given, the shooter may take the bird or not ; but if he fires, the bird must be deemed to be taken.
8. If, on the trap being pulled, the bird does not rise, it is at the option of the shooter to take it or not ; if not,

he must declare it by saying "No bird;" but should he fire after declaring, it is not to be scored for or against him.

9. Each bird must be recovered within the boundary, if required by any party interested, or it must be scored lost.
10. If a bird that has been shot at perches or settles on the top of the fence, or on any part of the buildings higher than the fence, it is to be scored a lost bird.
11. If a bird once out of the ground should return and fall dead within the boundary, it must be scored a lost bird.
12. If the shooter advances to the mark and orders the trap to be pulled, and does not shoot at the bird, or his gun is not properly loaded, or does not go off owing to his own negligence, that bird is to be scored lost.
13. A bird shot on the ground with the first barrel is "No bird," but it may be shot on the ground with the second barrel, if it has been fired at with the first barrel while on the wing; but if the shooter misses with the first and discharges his second barrel, it is to be accounted a lost bird, in case of not falling within bounds.
14. All birds must be gathered by the dog or trapper, and no member shall have the right to gather his own bird, or to touch it with his hand or gun.
15. In single shooting, if more than one bird is liberated, the shooter may call "No bird," and claim another shot; but if he shoots, he must abide by the consequences.
16. The shooter must not leave the shooting mark under any pretence to follow up any bird that will not rise, nor may he return to his mark after he has once quitted it to fire his second barrel.
17. Any shooter found to have in his gun more shot than is allowed, is to be at once disqualified. Any loader supplying in sweepstakes or matches cartridges loaded

- in excess of the authorised charge, will be dismissed from the Club grounds.
18. None but members can shoot except on the occasion of private matches.
 19. No wire cartridges or concentrators allowed, or other substance to be mixed with the shot.
 20. In all handicaps, sweepstakes, or matches, the standard bore of the gun is No. 12. Members shooting with less to go in at the rate of half a yard for every bore less than 12 down to 16-bore. Eleven-bore guns to stand back half a yard from the handicap distance, and no guns over 11-bore allowed.
 21. The winner of a sweepstakes of the value of ten sovereigns, including his own stake, goes back two yards; under that sum, one yard, provided there be over five shooters. Members saving or dividing in an advertised event will be handicapped accordingly.
 22. Should any member kill a bird at a distance nearer than that at which he is handicapped, it shall be scored no bird, but should he miss, a lost bird.
 23. $1\frac{1}{4}$ oz. of shot and 4 drams of black powder, or its equivalent in any other description of powder, is the maximum charge. Size of shot restricted to Nos. 5, 6, 7, and 8.
 24. All muzzle-loaders should be loaded with shot from the club bowls.
 25. If any bird escapes through any opening in the paling, it shall be a "No bird."

RULES FOR DOUBLE RISES.

1. In Double Shooting, when more than two traps are pulled, the shooter may call "No birds," and claim two more; but if he shoots, he must abide by the consequences.
2. If, on the traps being pulled, the birds do not rise, it is at the option of the shooter to take them or not. If not, he must declare by saying "No birds."

3. If, on the traps being pulled, one bird does not rise, he cannot demand another double rise ; but he must wait and take the bird when it flies.
4. A bird shot on the ground, if the other bird is missed, is a lost bird ; but if the other bird is killed, the shooter may demand another two birds.
5. If the shooter's gun misses fire with the first barrel, he may demand another two birds ; but if he fires his second barrel, he must abide by the consequences. If the miss-fire occurs with the second barrel, the shooter having killed with the first, he may demand another bird, but may only use one barrel ; if he missed with the first barrel Rule 5 in Single Shooting will apply.

MODIFICATIONS.

On the Continent the rules of the Cercle des Patineurs of Paris are usually adhered to, they are practically the Hurlingham Rules. The charge is limited : 4 drams of powder by measure, and $1\frac{1}{4}$ ounce of shot, is the maximum ; the boundary is 87 yards (80 metres) from the pavilion ; 54 yards from the centre trap, the traps are 5 metres from each other.

The shooter has a right to another bird if his gun miss-fires or refuses to go off through any fault not his own.

The pigeon is lost if the shooter has neglected to cock his gun, to load it, or to place on the cap.

If the first barrel misses fire, and the shooter fires the second, he loses his right to another pigeon, unless the second barrel also miss-fires.

If the second barrel misses fire, the shooter having fired and missed the bird with the first, he may claim another bird ; but in that case both barrels must be

loaded, the first with powder only, and neither barrel must be discharged until after the trap is sprung. It is forbidden to shoot both barrels at the same time.

The standard gauge is twelve, any gun of larger bore than this is handicapped half a metre for each size; thus ten bores, the maximum bore allowed, stand one metre back, fourteen bores advance half a metre, sixteen bores one metre; no further advantage is allowed to any smaller bore.

HINTS ON TRAP SHOOTING.

Trap shooting cannot be recommended as a profession. However good a shot a sportsman may be he will find so many uncertainties in trap shooting that it is doubtful if any person shooting continually will make trap shooting pay expenses.

At an ordinary bird, shot at under Hurlingham rules by an average good shot, the chances are five to two in favour of the shooter. To be considered a good shot the number of kills must average more than 70 per cent. Mr. "Grace," at one time considered a reliable shot, with a Greener Gun once scored a percentage of 84·3 kills in a series of International contests. Other shooters have occasionally made a higher percentage in a short series of matches.

In a series of International matches, out of 1,120 birds shot at by thirty-six different shooters, 79·9 per cent. were killed, and this is about the average in matches between first-rate shots.

The following hints may be of use to young shooters who wish to try their skill in trap shooting :—Commence at a short distance—say 18 yards—at live birds ; stand in an easy position, gripping the gun well forward with the left hand. This is a great aid in quick shooting. Do not stare at the trap which you think will give the most difficult shot to you, and if you do not particularly regard any trap so much the better.* Do not say “Pull” until you are quite ready to shoot, and have your attention concentrated upon what you are about to do. When the bird gets up, up with the gun quickly but steadily, and immediately you have it in place at the shoulder it should be aligned at the bird, and the trigger pulled. Pigeon guns should be so constructed that at forty yards’ range they will throw the body of the charge a few inches higher than the line of aim ; consequently, at any distance up to forty-five yards you will have the advantage over a bird rising in flight.

When shooting at thirty yards’ rise, this quality of the gun will be the more requisite, as to be a sure trap-shot you will require generally to kill your pigeon within four or five yards of the trap, and for that distance the pigeon generally rises, and if he does not do so immediately will, in all probability, do so long before he is out of range. The happy medium between snapping just over

* Captain Brewer’s position is facing the fourth trap, as he considers it easier to turn to the left.

the trap and "poking" after the pigeon must be sought.

In choosing a gun all will depend upon the rules under which it will be used, but it may be said that, as a rule, a gun of $7\frac{1}{2}$ lbs. will be the thing. Let it be taken from the rack just before going to the mark, and let a point be made of loading and cocking it methodically. Quite a large number of birds are scored lost every year because the shooter has forgotten to cock his gun, move the safety off, or some other cause, equally easy to prevent.

Hammerless-guns with automatically-bolting safeties are a great nuisance when pigeon-shooting. A hammerless pigeon gun should not have any safety upon it. If there is a safety it should be of independent action, and the trap-shooter will do wisely to have a screw pin put through it to prevent it being meddled with, or inadvertently put "on" by himself. As pigeon-guns are not loaded until the shooter is at the firing point, the gun is as safe without as with a locking safety bolt.

It is best to take no heed either of bystanders or trappers when going to the mark, and if one can be quite deaf to the shouts from the "ring" the score is likely to benefit.

In contending in a handicap it is the time spent in waiting between the rounds that tires and tries nerve and patience. At Monte Carlo a man may have to fire but nine times, and possibly have the whole of two afternoons in which to do it. Very

much, therefore, will depend upon the temperament of the shooter. In contesting a match at 100 birds it must be remembered that the task will be trying to endurance; and if a lighter gun can be found which suits as well as a heavy one, the use of it will enhance the shooter's chance of success. The shortest time occupied by the match will be two hours and a half, and it may drag along for double that time.

In match shooting the percentage of birds killed will be greater than in handicap shooting, and unless the shooter knows, by experience or former practice, that he can kill on the average ninety birds out of one hundred, he will do best not to contest a match with the best shots of the day.

Drive straight to the shooting-ground, so as to arrive at the time the shooting is advertised to commence. Waste no time in plating your gun. If the results of the shooting at the target should not please you, you will lose confidence in your gun and gain nothing. You should ascertain that the gun shoots well, and that the cartridges are suitably loaded *before* you get to the shooting-ground. Keep yourself to the matter in hand, and pay no attention either to the remarks of other contestants or the "betting." Having won or lost, leave the ground at once. Unless the ground is one not often visited, trial shots before the serious shooting commences are not to be recommended. Upon visiting a town for the purpose of contesting the

International Tournaments, it is best to lodge at some distance from the shooting-ground, and to go there only so often as the business of the contests may require. Nothing is gained by constantly hanging about in the vicinity of the shooting-ground, nor by experimenting upon it. You should go to the ground to kill every bird at which you shoot; you must practise and experiment upon a private ground elsewhere.

A little experience will soon prove to the young shooter whether it is best to take or leave a pigeon which does not rise immediately the trap is sprung, and in other ways how to *win*, providing he is a good shot, and can keep in perfect health.

PIGEON SHOOTING SCORES.

As shooters are always pleased to compare their own performances with those of acknowledged experts, the following accounts of matches, compiled from various sources, will occasionally be useful for reference.

In a series of three matches between Mr. E. D. Fulford and Captain Brewer in November, 1891, at New York, 100 birds each at 30 yards, Mr. Fulford, using a gun by W. W. Greener, scored the full number to his opponent's 99. The following day the scores were—Fulford, 99; Brewer, 98; the 95th bird shot at by Mr. Fulford fell dead out of bounds, thus practically 200 consecutive shots resulted in 200 kills, a truly marvellous

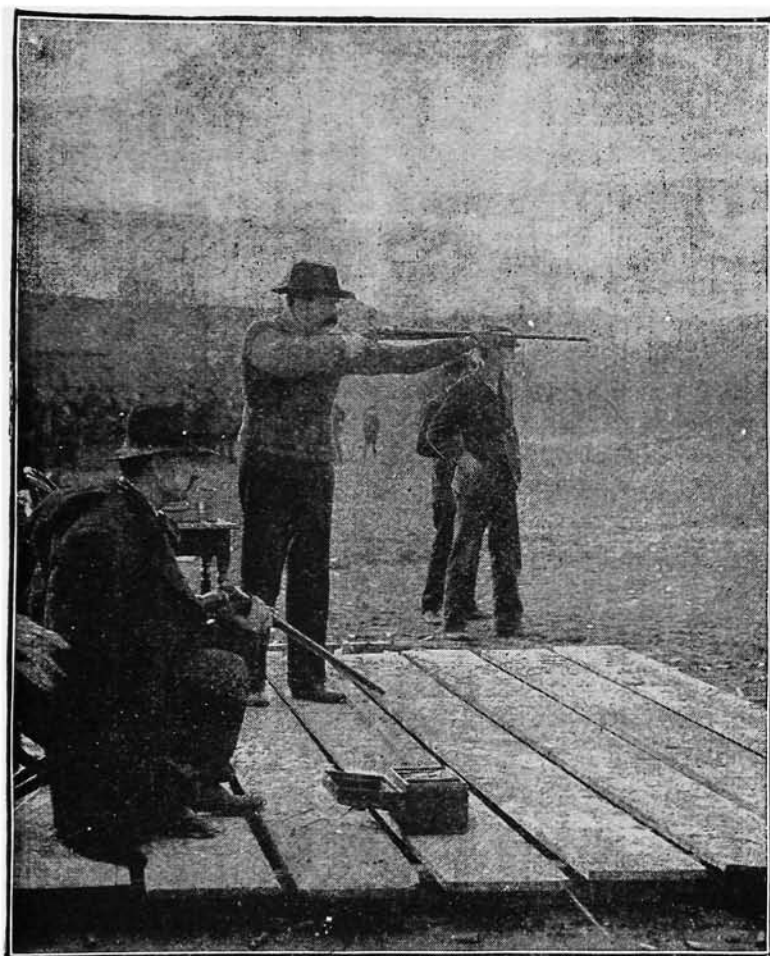

Fulford at the Score. (*From an instantaneous photograph.*)

performance which certainly no game shot could equal. This was the highest score ever made at the trap. The third match resulted in a tie, both gentlemen scoring 94 each. The tie was immediately shot off at 25 birds each, Captain Brewer killing all his birds while Mr. Fulford scored 24, leaving Mr. Brewer—who also used a Greener gun—the winner of the shoot-off by a single bird.

One of the best scores on record is that of Captain A. H. Bogardus, who on July 2nd, 1880, succeeded in scoring 99 birds out of 100, the 47th bird falling dead out of bounds. This extraordinary score was made in a match with Mr. Rimmell, an English gentleman, for 250 dollars aside. Bogardus, 30; Rimmell, 28 yards; 100 birds, 5 traps, weather fair, and birds in good condition.

In England Captain Bogardus never even approached the excellence of this score, his best recorded shooting being in a match with Mr. Dudley Ward, who shot a tie with him, each scoring 84 out of 100. Mr. Ward won in shooting off this match.

The match with Mr. Wallace, at the Gun Club Grounds, shot July 19th, 1878, resulted in a tie, each shooter scoring 69 birds out of 100. The following Wednesday the tie was shot off, resulting in a win for Mr. Wallace, he killing 71 birds to the captain's 69. On July the 23rd, in the same year, the captain shot a match with Mr. H.

Cholmondeley-Pennell at the same grounds; the scores being—Captain Bogardus, 71; Mr. Cholmondeley-Pennell, 69. These scores are amongst the best ever made in England.

Dr W. F. Carver, the celebrated rifle shot, was and is, an excellent performer with the shot gun. When in England in 1881 he shot off a series of matches of which the following are the best, as far as high scores are concerned :—

On March 16th, with Mr. W. Scott, 100 pigeons at 30 yards. Dr. Carver scored 79; Mr. Scott, 74. The longest string of consecutive kills was one by Mr. Scott, of 26. Both shots used guns by W. W. Greener.

Dr. Carver and Mr. Scott had previously (February 7th) shot a match at 100 birds, when the scores were :—Dr. Carver, 66; Mr. Scott, 62. The birds were the finest and quickest seen during the winter, and the weather was vile, the greater part of the match being shot in a blinding snowstorm and a driving squall from the south-west.

In America in 1884 Dr. Carver shot a series of matches with Captain Bogardus. The following are the scores and distances :—First match (at Louisville, Ky.; 100 birds, 30 yards rise, 80 yards boundary, Hurlingham rules)—Carver, 83; Bogardus, 82. Second match (at Chicago; same conditions as first match)—Carver, 82; Bogardus, 79; at the 80th round scores were even, and remained so until the 90th, when Carver killed all succeeding

birds, and won a well-contested match by 3 birds. Third match (at St. Louis; 50 double rises at 21 yards)—Carver, 79; Bogardus, 81.

At Hendon, in March, 1881, Dr. Carver won the Championship of the World Challenge Cup, presented by the proprietors of *The Sportsman*, value £100, added to a sweepstakes of £50 each, and part of the gate money. There were 13 competitors, who fired at 50 pigeons each, 30 yards rise, usual conditions.

Dr. Carver made several matches with the best trap-shots of England. He was beaten once by Mr. Heygate, of The Gun Club, in a match of 25 birds a side.

Dr. Carver tied with Mr. A. J. Stuart-Wortley in a match for £500 a-side, shot at the Hendon Ground, December 8th, 1882 — score, 83 each. This match was the more exciting from the fact that at the 50th bird the scores were equal, as they were again several times during the last part of the match and at the finish.

Dr. Carver's string of 50 birds killed straight off, which he accomplished at Lynchburg, Va., U.S.A., with a Greener $7\frac{1}{4}$ lbs. 12-bore gun, is his best on record in this line.

A final contest for the Championship of England Cup took place at Hendon on July 3rd, 1888, and resulted in a win for Captain Brewer, who killed 24 out of 25 birds, at 30 yards rise, and having thrice consecutively gained the prize against

all comers, claimed the trophy as his own. Captain Brewer used a Greener gun in all contests.

In the contest for the American Field Champion Wing-Shot Cup, 1890, Mr. Elliott, the holder, successfully defended it with a Greener gun, scoring 59 out of 60, 48 out of 50, and 94 out of 100 birds.

In the celebrated three days' match between Mr. Elliott and Mr. Brewer, shot off at the Jersey City Heights Gun Club, both contestants used W. W. Greener's hammerless guns. The conditions were 100 birds each man each day; distance, 30 yards. The score was 93 each; the tie was shot off at 25 birds each, out of which Brewer killed 23 and Elliott 21. On the second day Mr. Brewer killed 69 straight off, the 70th fell dead out of bounds, and finished with 30 kills—score: Brewer, 99; Elliott, 92. On the third day, Brewer scored 93 and Elliott 89. This shooting is equal to the record score made by Captain Bogardus in 1880; and Captain Brewer has since, at a recent trial at Long Branch, killed 105 pigeons in succession.

Mr. J. A. R. Elliott is a brilliant and reliable shot, and has won eight times successively the American Field Champion Wing-Shot Cup, each time with a W. W. Greener gun.

The advantage of snap-shooting is clearly shown in the following extract from the *Forest and Stream*, of New York, of May 5th, 1891:—

“ELLIOTT *v.* FULFORD, for the American



American Champion Wing-Shot Cup. Became the property of Mr. J. A. R. Elliott, of Kansas City, on July 30th, 1892, he having held it against all comers for two years.

Field-Champion Wing-Shot Cup.—Mr. C. W. Budd, who umpired the match, sends us the score, with these comments by the local reporter :—

“Considering the day, the scores made by both shooters were remarkably good. The wind was blowing a perfect gale from the south-west, and once a bird got started from the traps and got up in the wind he went away like a streak of lightning.

“The difference in the style of the two men was in Elliott’s favour under these conditions. The Kansas City champion shoots very quickly, and thus was enabled to kill many birds close to the traps. Fulford, on the other hand, is rather a deliberate shot, and he made difficult birds out of a number of them by letting them get too far away.

“In the drawing of the birds the men had about equal luck, each getting about the same number of drivers. The largest consecutive run was made by Elliott, who grassed his last 37 birds straight. The score shows that Elliott used his second barrel more frequently than did Fulford, but on a majority of the birds this was used simply for safety. There was a large attendance of shooting men, and the victory of Elliott was well received.

“Elliott shot his Greener, weighing 7lb. 3oz., and Fulford used his Hammer Greener, weighing 7lb. 11oz. Both men used Schultze powder in both barrels. Elliott, 46, winning the cup for the eighth time; Fulford, 43. Conditions—50 birds each, 30 yards rise.”

The greatest prize and highest honour ever shot for is the *Championnat Universel*, the one triennial event of the Monte Carlo International Meetings. This was won with a W. W. Greener gun, in 1886, by Mr. H. C. Pennell (who also won the *Grand Prix du Casino* in 1878 with his Greener gun), and again by Mr. W. Blake, in 1889, and it may interest some to know that neither of these shots was measured for his gun ; indeed, the gun used by Mr. Pennell was an ordinary weapon from stock, and a few hours before the match commenced the right or upright trigger was changed to act upon the left lock and *vice versa*.

The winners of the *Grand Prix du Casino* must also be considered amongst the best of trap shooters. This match is contested for by the best trap shots of all nations, and the birds are supplied by one of the most esteemed purveyors, whilst the Monaco boundary is acknowledged to be much in favour of the bird. The contest extending over several days also necessitates careful shooting over an extended period, and to kill 13 consecutive birds without a miss, firing only at long intervals, is evidence of the ability of the marksman.

The following gentlemen have won the *Grand Prix du Casino* :—

Year.	Winner of the Grand Prix.
1872—	Mr. George L. Lorillard (American).
1873—	Mr. J. Jee, V.C., C.B. (English).
1874—	Sir Wm. Call, Bart. (English).

- 1875—Captain Aubrey Patton (English).
 1876—Captain Aubrey Patton (English).
 1877—Mr. W. Arundel Yeo (English).
 1878—Mr. H. Cholmondeley-Pennell (English).
 1879—Mr. E. R. G. Hopwood (English).
 1880—Comte Michel Esterhazy (Hungarian).
 1881—M. G. Camaueur (Belgian).
 1882—Comte de St. Quentin (French).
 1883—Mr. H. T. Roberts (English).
 1884—Le Comte de Caspela (Italian).
 1885—M. Leon de Dorlodot (Belgian).
 1886—Signor Guidicini (Italian).
 1887—Count Salina (Italian).
 1888—Mr. C. Seaton (English).
 1889—Mr. V. Dicks (English).
 1890—Signor Guidicini (Italian).
 1891—Count Gajoli (Italian).
 1892—Baron Trautmannsdorf (Austrian).

In several instances the killing of a dozen pigeons in succession has taken the Grand Prix, as was the case in 1887 and 1888, and in 1891 Count Gajoli, with his Greener, killed his 5 birds at 26 and 5 at 27 metres.

INANIMATE TARGETS.

As a pastime the shooting at glass balls or bottles has long been practised in this country, but was developed and made a fashionable amusement in the United States by Mr. Ira Payne, Captain Bogardus, Dr. Carver, and other professional shots.

The inanimate targets now in use may be

divided into two distinct classes—balls and “pigeons.”

The balls, at first plain hollow spheres of colourless glass, were afterwards made of blue or amber glass, and filled with feathers; later the spheres were chequered to prevent the shot from glancing, and this stage of development is the highest reached by the glass ball. Balls made of various resinous compositions have been tried, and have a certain sale, but as there is difficulty in getting them suffi-

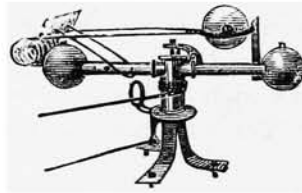

The “Carver” Revolving Trap.

ciently brittle they have not generally supplanted the glass balls. Other plans have been tried, as bell balls, puff balls, explosive balls, etc., but they have not proved successes commercially.

The traps to throw the balls have been wonderfully developed. From the modified catapult used at English fairs they have advanced to a rotating trap which simply defies trickery on the part of the trap puller or his assistants.

The “Hatch” was one of the first popular traps, it was followed by the “Bogardus” and the “Carver,” which has a coil spring instead of

a flat one. The "Mole" was an early rotating trap; the card was an improvement upon it, and the modern rotating trap is a close copy of its most approved pattern.

The Ligowsky clay pigeon trap was the next improvement in the way of an inanimate flying

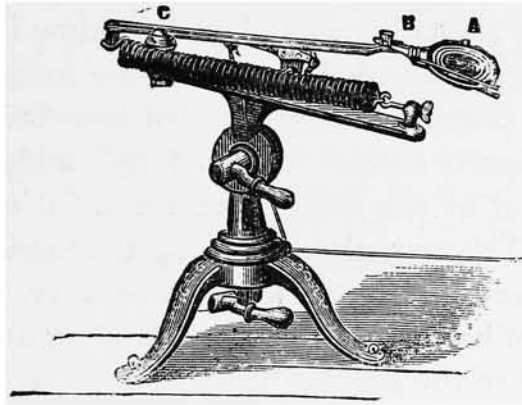

The Blue Rock Trap.

target; the trap now much improved, and pigeons also perfected, are still on sale.

Instead of "glass balls" or "clay" pigeons, the broken fragments of which are objectionable on lawns and in parks, thin brass balls or pigeons filled with fine powdered charcoal may be obtained; when fairly struck they emit an unmistakable cloud of dust, and the worn-out targets are readily collected. Inanimate targets made of a composition of resin and plaster, coal tar, and ashes, or other suitable materials worked up until thoroughly incorporated and moulded under great pressure, are

now largely used ; they fly well, break easily when struck, and are so coloured as to be visible against any background.

Good traps such as the "Standard," "Keystone," "Blue Rock," or "Peoria," will throw these targets so well as to afford excellent practice even to good shots. Nothing affords so much amusement with the gun at a small cost, and as a pastime it may be strongly recommended to all who are fond of snap-shooting. The trap recommended is so constructed that it imparts to the thrown target a high rotary motion, and at the same time throws it with little friction. The trap also so throws the target that it has a steady flight and a good velocity, which is not perceptibly greater at the commencement than at the end of the flight.

There are certain accessories necessary, such as cords, planks, and holding-down pins, and clubs will also provide themselves with pulling gear ; and whether using three or five traps, will decide upon a definite method of determining in which order the traps shall be sprung. The use of dice or a trap-pulling indicator will effectually prevent collusion between the shooter and puller.

The following rules are those generally observed in inanimate target shooting, and with little or no alteration may be applied to matches with any number of traps.

RULES FOR INANIMATE TARGET SHOOTING.

1. DECISION OF JUDGES.—Two judges and a referee shall

be appointed to judge all matches. If the judges cannot agree, the referee shall decide, and his decision shall be final.

2. **SPECIAL DUTIES OF REFEREE.**—The referee shall see that the traps are properly set at the beginning of a match, and that they are kept in order to the finish.
3. **FLAGS FOR JUDGES.**—Each judge shall be provided with a red flag and a white flag. They shall raise the red flag to indicate a “broken” bird, and the white flag to indicate “lost” bird; they shall raise both flags to indicate “no bird” or an imperfect bird; they shall also announce the score in a loud voice.
4. **KEEPING THE SCORE.**—It shall be optional with the judges and referee to keep the score themselves, or appoint some one for that purpose, and the score thus kept shall be the official score, provided, however, that the referee must testify to the correctness of the score or scores made under his supervision, if required.
5. **SCORE WITH INK.**—All scoring shall be done with ink or indelible pencil; the scoring of a lost bird shall be indicated by a “0;” of a dead or broken bird by a “1.”
6. **TRAPS.**—All matches shall be shot from three traps set level, in the segment of a circle 5 yards apart. The radius of this circle shall be 18 yards. The traps shall be numbered from No. 1 on the left to No. 3 on the right consecutively. All traps must throw the birds a distance of not less than 40 yards.
Each trap must be tested for this standard distance before the shooting begins, and if any trap be found too weak to throw the required distance, a new trap or spring must be substituted.
7. **ADJUSTING TRAPS.**—The lever or projecting arm of the trap shall be so adjusted that the elevation of the bird in its flight at a distance of 10 yards from the trap

shall not be more than 8 feet nor less than 4 feet, and the angles of flight shall be as follows :—

No. 1 trap shall be set to throw a left quartering bird.

No. 2 trap shall be set to throw a straight-away bird.

No. 3 trap shall be set to throw a right quartering bird.

After the traps are set for the above angles, if the bird for any reason shall take a different angle, it shall be considered a fair bird, provided the trap has not been changed.

8. PULLING OF TRAPS.—The trap-puller shall stand at least 6 feet behind the shooter, and when the shooter calls "Pull," the trap or traps shall be instantly sprung. In single bird shooting he should pull the traps indiscriminately, and not one, two, and three consecutively. He shall pull equally and regularly for all shooters. If the bird is sprung before or at any noticeable interval after the shooter calls "Pull," he can accept the bird or not, but if he shoots the result shall be scored.
- 9.—SCREENS.—No screens shall be used. Back-stops may be provided for trappers, not to exceed 10 yards from the end traps, and not to exceed 3 feet in height.
- 10.—DISTANCE.—In single bird shooting the rise shall be 18 yards for 10-bore guns, 16 yards for 12-bore guns. In double bird shooting the rise shall be 15 yards for 10-bore guns, 14 yards for 12-bore guns.
All distances mentioned in these rules must be accurate measurement.
- 11.—GUN.—No gun of larger calibre than 10-bore shall be used.
- 12.—LOADING GUNS.—In single bird shooting only one barrel shall be loaded at a time, and the cartridge shall not be placed in the barrel until after the shooter has taken his position at the score ; in double bird shooting both barrels to be loaded at the score.
- 13.—POSITION OF GUN.—The butt of the gun shall be held

below the armpit until the shooter calls "Pull." If this rule be violated, and the bird is missed, it shall be scored as a "lost bird." If it be broken, it shall be declared "no bird," and another shall be shot at.

14. **BROKEN BIRDS.**—A bird to be scored broken must have a perceptible piece broken from it while in the air. The decision of the judges and referee on this point shall be final. No bird shall be retrieved to be examined for shot marks.

If a bird be broken by the trap the shooter may claim another bird, but if he shoots, the result must be scored.

15. **SINGLE BIRD SHOOTING.**—Each contestant shall shoot at three birds before leaving the score. If two birds are sprung at the same time, it shall be declared "no bird."

16. **DOUBLE BIRD SHOOTING.**—Both traps must be pulled simultaneously, and each contestant shall shoot at three pairs consecutively, thrown as follows :—

First pair from No. 1 and 2 traps. Second pair from No. 2 and 3 traps, and third pair from No. 1 and 3 traps. If only one bird is thrown it shall be declared "no birds," and if the gun miss fire on either bird it shall be declared "no birds." In each and all such cases another pair of birds must be shot at.

- 17.—**TIE SHOOTING.**—All ties shall be shot off at the original distance, and at the number of birds agreed on by the contestants. If, however, the contestants cannot agree promptly on this point, the referee shall fix the number, and his decision shall be final. The rules prescribed for single and double bird shooting shall prevail in tie shooting.

- 18.—**CHALLENGE.**—No challenge shall be considered unless the parties challenging are contestants.

THE BEST RECORDS.

The best records made at inanimate targets are

very much higher than anything obtained from live bird shooting. According to a list recently published there are more than a dozen shooters in the United States who have broken 100 of the inanimate targets without a miss, and the score made and recorded at a public competition. Upwards of fifty shooters have scored more than 90 out of 100.

“Young Nimrod,” an English boy, has, with his 28-bore gun and $\frac{3}{4}$ oz. of shot, frequently scored 88-100 at clay pigeons.

In a series of twenty-five matches, at 100 clay pigeons each at each match, between Dr. Carver and Capt. Bogardus, 2,227 were broken by Dr. Carver, and 2,103 by Capt. Bogardus, at 18 yards rise. Dr. Carver made two scores of 100 each without a miss, and won nineteen matches, tied in three, and lost three. His lowest score was the first—72; and twenty of his scores exceeded 90 broken. Capt. Bogardus once scored 99, his highest, and three times 63, his lowest in this series of matches.

At glass balls still less skill is required; but the best record is Mr. Scott's — 700 smashed consecutively with a Greener gun. Dr. Carver, in a match with Mr. Scott, broke 9,737 out of 9,950 shot at; Mr. Scott, 9,735 out of the same number. Out of the last 950 in this match Dr. Carver missed two only, and Mr. Scott three.

The quickest time recorded for breaking 100 glass balls with a shot gun is just under five minutes.

Capt. H. Bogardus, the great American wing shot, made a match against time in December, 1879, and succeeded in breaking 5,500 glass balls in a few seconds less than 7 hours 20 minutes. The misses numbered 356. The captain used an English gun with two pairs of barrels—one pair (10-bore) shooting 4 drams of powder and $1\frac{1}{2}$ oz. of No. 8 shot; the 12-bore pair were loaded with $3\frac{1}{2}$ drams 1 oz. of No. 8 shot. During the match the captain loaded for himself, and changed the barrels no less than fifty-five times. Three miss-fires only occurred in the whole series of 5,855 shots. The balls were all sprung from spring traps.

At a gun trial held at Leavenworth in 1886, a Greener 12-bore gun was shot with "King's Quick Shot" powder, an explosive the author has never had an opportunity of trying. The gun beat all its opponents easily—some were much heavier guns and larger calibre.

HOW EXPERTS SHOOT.

The most skilled exponents of the art of wing shooting should be able to give some hints of value to all who wish to become expert in the use of the shot gun. The author having unique opportunities for acquiring a knowledge of the methods followed by professional trap shots in aiming and handling the gun, is enabled to give a few facts which prove how diverse are the modes of unerring shots, and how different the advice which would be given by

various successful shooters. Dr. Carver shoots on the snap-shot system, shooting both barrels in quick succession *at* the pigeon. Captain Brewer shoots *at* some pigeons, and holds ahead of others, determining which to do immediately the bird is released from the trap. Mr. J. A. R. Elliott, than whom there is, perhaps, no better or steadier all-round trap shot, also follows the dual plan. He shoots on both systems most successfully, and is able to change his methods of shooting from one pigeon to the next. He appears to shoot most rapidly, but is in reality a most deliberate shot, judging every bird the instant it takes wing, shooting slowly at a slow-flying bird, and very quickly, and with both barrels, when a quick-flying bird is released. With quartering birds, that is at cross shots, it is his invariable plan to hold ahead of them, estimating the angle in which and the rate at which they are flying, and leading them from six inches to two feet with the first barrel, and from two feet to six feet with the second. This ability of accurately judging the flight of birds and the allowance necessary to grass them won him the match at fifty birds with Mr. Fulford. The wind was high at the commencement, and developed into a stiff gale during the match, and blowing irregularly made it almost impossible to gauge accurately what wind allowance should be made. The first dozen birds were shot at with a light gun, with a charge of $3\frac{1}{2}$ drams of Schultze,

and $1\frac{1}{4}$ ounce of No. 6 shot ; at the fourteenth bird a heavier gun was taken and No. 5 shot used. The match finished with thirty-seven killed straight, the score being 46-50 to Mr. Fulford's 43-50. With the second gun and heavy shot Mr. Elliott shot very rapidly, catching his birds as near the trap as possible, and using both barrels.

Mr. Fulford, whose score of 194 grassed in succession has never been approached, holds ahead of his birds. Having ascertained by actual experiment that at forty yards his shot was stringing from twenty to thirty feet, he took that margin in shooting, and found that whether holding a little high or a little low he still killed the pigeon clean, providing that he held eight to ten feet ahead of a bird going across.

The great stringing of the charge is due to the heavy charge of explosive used. The average stringing in a properly loaded gun is about ten feet at forty yards ; this is equal to a drop in the mean velocity from 900 feet per second (the velocity of the first pellets of the charge) to 650 per second (the velocity of the last pellets of the charge).

The swiftest flying pigeon travels at about one-third the rate of a charge of shot at thirty yards, and whilst theoretically it is correct to lead a quartering pigeon from five to seven feet, there are few trap shots who do it.

TABLES OF THE PATTERNS MADE BY THE BEST GUNS IN
THE LONDON GUN TRIALS OF 1859, 1866, 1875, 1878, 1879, AND
THE AMERICAN GUN TRIALS OF 1873, 1874, 1879.

	Bore.	drams.	oz.	shot.		Pattern Right. Left.
LONDON GUN TRIAL,						
1859—						
Muzzle-loader	12	2 $\frac{3}{4}$	\times	1 $\frac{1}{2}$	No. 6	290 pellets to oz. 158 118
Breech-loader	12	3	\times	1 $\frac{1}{2}$	No. 6	144 90
LONDON GUN TRIAL,						
1866—						
Breech-loader	12	2	\times	1 $\frac{1}{8}$	No. 6	280 pellets to oz. 131 123
Breech-loader	16	2 $\frac{1}{2}$	\times	1	No. 5	100 118
LONDON GUN TRIAL,						
1875—						
*Breech-loader	12	3 $\frac{1}{4}$	\times	1 $\frac{1}{8}$	No. 6	270 pellets to oz. Average. 214
*Breech-loader	10	4	\times	1 $\frac{1}{2}$	No. 6	241
*Breech-loader	20	2 $\frac{1}{8}$	\times	1	No. 6	145
*Breech-loader	8	6	\times	2 $\frac{1}{2}$	No. 6	358
LONDON GUN TRIAL OF						
EXPLOSIVES, 1878—						
Breech-loader	12	3 $\frac{1}{4}$	\times	1 $\frac{1}{8}$	No. 6	220-08
LONDON GUN TRIAL,						
1879—						
Breech-loader	12	3 $\frac{1}{4}$	\times	1 $\frac{1}{8}$	No. 6	Chilled shot. 270 pellets to oz. 223
Breech-loader	16	2 $\frac{3}{4}$	\times	1	No. 6	174
Breech-loader	20	2 $\frac{1}{4}$	\times	$\frac{7}{8}$	No. 6	174
NEW YORK GUN TRIAL,						
1873—						
Breech-loader	12	3	\times	1 $\frac{1}{8}$	No. 6	Shot with paper shell 150
Breech-loader	12	3 $\frac{1}{2}$	\times	1 $\frac{1}{8}$	No. 6	Shot with metal shell 211
Breech-loader	10	4 $\frac{1}{2}$	\times	1 $\frac{1}{4}$	No. 6	Shot with paper shell 211
CHICAGO GUN TRIAL,						
1874—						
Breech-loader	12	4	\times	1	No. 7	309 pellets to oz. 180
Breech-loader	10	4 $\frac{1}{2}$	\times	1	No. 7	191
CHICAGO GUN TRIAL,						
1879—						
Breech-loader	12	3 $\frac{1}{2}$	\times	1 $\frac{1}{8}$	—	291 pellets to oz. 170
Breech-loader	10	4	\times	1 $\frac{1}{4}$	—	200
Breech-loader	16	2 $\frac{1}{2}$	\times	1	—	163
Breech-loader	20	2 $\frac{1}{2}$	\times	1	—	138

* These four guns were shot in the selected circle, and with chilled shot.

LONG SHOTS.

The extracts from a few letters received by the author will best serve as instances of exceptionally long shots which have recently been made. One sportsman, writing from Canada, says :—

“Since I have had my Treble-Wedge Fast 12-bore hammerless gun, 28 inches long, $7\frac{1}{2}$ lbs. weight, forty guinea quality, made by you in 1880, I have made many exceptionally long shots in duck-shooting.

“In the month of October this fall, however, I made three shots which, in justice to you, are deserving of especial mention. On the occasion in question my gun, which is full choke in both barrels, was charged with $3\frac{1}{2}$ drs. of Curtis and Harvey’s No. 4 powder, with one felt and two cardboard wads between powder and shot, and $1\frac{1}{8}$ oz. of No. 2 chilled shot with cardboard wads.

“With the first shot I killed two black ducks crossing on the wing at 75 yards, with the second a single blue bill (small duck) sitting at 100 yards, and with the third a single black duck sitting at fully 110 yards. When the length and weight of my gun, and the moderate charge of powder, and the large size of the shot used, are taken into consideration, I think the three shots in question, which were all fired one after the other within an hour’s time, are worthy of ranking as extraordinary shots.”

From another gentleman the author has just received the following :—

“Mr. W. W. Greener,
“*Birmingham.*”

“DEAR SIR,—The little 16-bore Ejector gun I ordered came to hand, and I have had a good opportunity of testing it, and must say I am very much pleased with it.

“I killed some geese at 50 to 55 yards with it, using 3 drs. E.C. and 1 oz. No. 1 shot, but of course it is not a goose gun.”—F. G. S., *May 17th*, 1892.

From THE FIELD, December 9th, 1876.

GROUSE DRIVING, BY SIR FREDERICK A.
MILBANK.

SIR,—Having read several letters in *The Field* on the subject of choke-bores, perhaps a few lines from one who has given it a severe and fair trial may be of value. Since September 1 I have been shooting grouse with a full choke, made by W. W. Greener, of Birmingham, and I can verify, through experience, its wonderful shooting powers. My usual practice in grouse driving is to take two guns into the “stands” (called by some butts). Consequently, I decided upon taking my full choke and one of my old guns, my object being to fire the choke at long shots when birds came singly or two together; but when birds came thick, I kept

up a continuous fire, oftentimes till both guns were too hot to hold comfortably. In these cases birds were killed at all sorts of distances, from twenty to fifty and sixty yards. I fired away promiscuously with both guns, and I can state positively in no one instance did I ever see a bird "blown;" and after a drive was over, when twenty to thirty brace of birds were picked up, myself, friends, and keepers could not discover a single bird that was hard shot. Moreover, after a day's driving, when perhaps two hundred brace of grouse were hanging up in the larder, no one could detect the "blowing" of a single bird.

Perhaps some of your critics may take exception to my "choke," and think it does not shoot close and hard: I ask them to read to the end of my letter before they arrive at any such conclusion.

When shooting with such rapidity with the two guns it is perfectly impossible to say how many shots are fired from the one gun, but I am not above the mark when I say I fired 120 shots with the choke-bore daily. As I have attempted to describe what I did at haphazard shots, allow me to say something as to the wonderful shooting at long distances. Grouse at the beginning of October commence congregating in what we call in North Yorkshire large "packs" of hundreds together, and they take up their abode on the large flat mosses, which in many instances are situated on the tops

of the high hills; when disturbed by the drivers, they take their flight from one hill to another. The "stands" in many places being below the hills, it naturally follows the birds cross over at a great height, and become what is usually called "rocketers." Here comes to the fore the very great superiority of the choke-bore. I have often killed birds at such a height, that my friends shooting with me with their old guns never even attempted to fire at them. Remember, I don't take what I call "fluke shots" into consideration, as many guns can and will do this; but when you find the choke can go on doing this successively, the point can never be disputed as to the superiority of one weapon over the other. Again, as to cross shots. Birds passing the stand at any number of miles an hour in a gale of wind, I fancy, tell more than any other as to the excellence of a gun, for the birds come at a tremendous pace, sailing along with their feathers closed, and without a movement of the wing. I have often in a day stepped distances of sixty-five yards and thereabouts, where the birds have been killed stone dead. It would be useless on my part to enter into further particulars as to the excellent and, I may say, wonderful, shooting of the choke-bore above all other guns, because shooting so often. There was not a day but what the gun excited in many instances the admiration of myself and others. But I wish to add a short statement, which conclusively bears

out all I have stated. In the third week in November I went out partridge shooting in Yorkshire (birds, as every one knows, are as wild as hawks at this season of the year). Accompanying me were two gentlemen, both quite first-rate shots. All three of us had equal chances throughout the day. At the end of it one of my friends had seven brace, the other six brace, but the choke had sixteen and a half brace. I advisedly say the "choke," because I was fully convinced that the gun alone was the cause of my overtopping my friends by so large a number. I measured that day three successive shots—65, 71, and 62 yards! In my honest opinion, I look upon the full choke-bore as the greatest and most wonderful improvement ever made in a gun, and I prophesy in a few years we shall hear but little of the old style of boring. I have observed in some of the letters you have published that questions have been asked as to the cartridges. I have given no particular orders on this point to my gunmaker, only telling him to send me green Eley gas-tight cartridges, 12-bore central fire, $3\frac{1}{4}$ drams of powder, one ounce and an eighth of No. 5 chilled shot; and I have nothing to complain of. It may be asked why I did not shoot with the choke-bore in August. My answer is, I did not commence grouse shooting until the 23rd of August, and as a choke was new to me, I felt the alarm of others, viz., "that it would blow birds to pieces;" but I have since learnt the

contrary, and I shall be surprised if next year I shoot with any other guns.

FREDERICK A. MILBANK.

Wemmergill Lodge, December 5.

P.S.—I have fired away upwards of 4,000 cartridges on the moors, two-thirds of which have been with the choke.



From THE FIELD, December 23rd, 1876.

SIR,—I was aware, when I wrote on the subject of choke-bores, that my letter would be criticised. J. W. G. S. believes that my experience with choke-bores has been confined to grouse and partridge shooting, but this is not the case, and I only made the statement referred to because I had given the gun what I consider a very severe and excellent trial at that description of game. However, I can now further state that I have tried it at

“very hot corners” at pheasants, and I defy any one, after a day’s shooting, to point out a single bird that has been “blown.” My experience has proved beyond doubt that the choke-bore does not blow pheasants or any other game to pieces at 20 yards.

As for general shooting, I have not the slightest hesitation in saying that the choke is incomparably the best gun. Snipe and woodcock shooting, as far as I am concerned, partake too much of the *rara avis* character to test the shooting of a gun; but I have shot a good many snipe with the choke on the moors, and I have never found any more difficulty in bringing them down than I have grouse or partridges.

W. C. does not agree in my prophecy as to the universal use of choke-bores in a few years’ time. He says in confirmation of his opinion, that he has “seen it proved to his satisfaction that right and left cannot be taken in such good style as with smooth-bores.” Why not? Suppose two birds rising together at forty yards, flying straight away from you, I maintain that a good shot should kill both to a certainty with the choke, whereas with the smooth-bore the chances are immensely against you. And as to closer shots, I think I have proved on grouse driving and partridges (see my last letter), that birds are killed as easily by the choke as any other gun. Therefore, I maintain, if you can kill right and left at very long range, and the

same at close range, the choke-bore undoubtedly shows a great superiority.

W. C. wishes for a trial at pigeon shooting, but I say no pigeon shooting (which is a knack) can shake the practical experience of the severe trials I have subjected the choke-bore to. We cannot ignore the test all guns were put to at the great gun trials at Wimbledon, which proved beyond doubt the superiority of strength and hardness of shooting of the choke over other guns. Instead of W. C. wishing for a trial at pigeons, let him make a match with the old style of gun against the choke, either at a target of 40, 50, 60, or 70 yards, or a hard day's shooting where game of all sorts is plentiful. If at the target, try it at 18 in. by 12 in. at all distances; then you will see the extraordinary shooting powers of the choke.

Apropos to this, I may state that one day last September I was staying at a house in Scotland. The morning being wet, we were prevented shooting. I suggested a trial of our guns. Consequently seven guns, made by the most eminent firms in the trade, were brought out to compete against W. W. Greener's choke. We tried the guns at the distances I have named, and in every instance the choke proved eminently successful. If you try it at a hard day's shooting (as I have done) at all sorts of game in October, and where the shooters are excellent shots, you will find the bag at the end of the day decidedly in favour of the choke-bore.

It is not in my power to give the gun a severer trial or a better one than I have already done. I had no partiality in the matter, having purchased a choke-bore purposely to find out whether it was superior to other guns. I have found this to be the case, and I think you will allow that my test has been a good one. I state truly my opinion when I say that I believe the full choke to be the greatest improvement ever made on the sporting gun in modern times.

I cannot conclude without making a few remarks on A. F.'s letter, as he is labouring under a very great mistake when he says I "fail to establish the fact of the choke-bore being useful for any description of shooting, except grouse driving, and then only when the stands are very much lower than the flight of the birds." Can A. F. seriously think this? I gave that instance of height to show what choke-bores can do; he surely cannot suppose that all stands are so situated. He forgets that I instanced birds coming cross shots—skimming the ground at great distances off. However, to put him right, I may state that the stands on a large moor are placed in every sort of situation—under hills, on brows of hills, on flats, edges of deep ravines, &c., and yet the choke has never failed, in my experience, to do its duty.

I do not say that you must shoot with chilled shot in covert. I believe chilled shot to be the best; but if there is a fear of reducing "accidents

to a certainty" (as A. F. states) by its use, then use the common lead shot, which will not disappoint you. He also adheres to the theory that "if a choke is held straight it will smash birds at 20 yards." Experience is a stubborn fact, and in the many thousand shots I have fired, at all distances, not a single bird has been blown.

To conclude, I may mention that since writing my letter in *The Field* the week before last I have been reminded by my keeper that at one drive in October I killed with the choke forty-seven grouse; so I have a strong idea in some instances I "held straight," yet not a single bird was blown.

FREDERICK A. MILBANK.

Wemmergill Lodge, Yorkshire, December 19.

[So convinced is Mr. Milbank of the superiority of the choke-bore over the cylinder-bore, that he has ordered another gun to have the barrels made full choke, to shoot as close as W. W. Greener can make them.]



Extracts from the London "Field."

From THE FIELD, December 23rd, 1876.

When shooting hares in the open, on some salt marshes in Lancashire, where some 1,100 were killed in three days—which said hares got up straight in front of you some 30 yards off, with their ears down—the chokes I found would stop them, when the ordinary guns only wounded.

For covert shooting here also, where the pheasants, flying down from steep hill coverts, puzzle ordinary guns, and where in many cases it is necessary to erect high stages to shoot from in order to get within range at all, the chokes, loaded with a heavy charge of powder and double wads over it, with $1\frac{1}{2}$ oz. of No. 4 chilled shot, render an excellent account of themselves.

R. L. LLOYD PRICE.

Rhiwlas, Bala, N. Wales, December 18.

My gun is one of W. W. Greener's first quality, 28-in. barrels, 6 lb. 10 oz., both barrels full choke. I used it on partridge the first half of September with a light spread charge ($2\frac{3}{4}$ drs. and 1 oz. No. 6, card wad only between powder and shot) in both barrels, and found it all I could desire. When birds got a little wilder I introduced the ordinary long-range charge for the second barrel, and frequently brought down birds dead at 50 yards to over 60 yards. I have used the spread charge with good results in covert shooting, on pheasants, hares, rabbits, and woodcock, without in a single instance spoiling either fur or feather.

I find it kills well up to 40 yards. With the ordinary long-range cartridge, loaded with No. 5 shot, I have on three occasions killed pheasants dead at over 60 yards. But, apart from the extra range gained with the choke-bore, there is another and to my mind a more important advantage—I mean the style in which it kills at the middle distances—30 yards, 35 yards, and 40 yards. This is noticeable with all kinds of game, but perhaps especially with hares. The collapse of a hare under the choke-bore, with No. 4 or No. 5 shot, is remarkable.

The accusation against “chokes” of smashing the game is, I believe, much exaggerated. With the ordinary cartridge I have killed pheasants, hares, and rabbits within 20 yards, and they have not been shattered. The new gun seems to me much less objectionable in this respect than the old gun with the concentrator.

In conclusion, I would say to those seeking information and advice, “If you are a fair shot, and want a new gun for general shooting, by all means get a choke-bore; but do not go to a second-rate man, or to one who does not believe in chokes, but will make you one if you like. Go to one of the makers whose names are associated with these guns, and who ‘do believe in them.’”

Lancashire, Dec. 18.

FIAT EXPERIMENTUM.

From THE FIELD, January 6th, 1877.

SIR,—Soon after *The Field* trial of choke-bored guns, I ordered a full-choke of Mr. Greener, at the same time sending him my old gun, a first-rate tool made by Dougall, which fitted me exactly, as a pattern, that the weight, bend, and set-off might be the same in the new gun. I have used the Greener during the last two seasons as much as or more than the old gun. I have never troubled myself about special cartridges or special charges, but use it just as I would an ordinary gun, and the result is perfectly satis-

factory. For partridge driving it is all that one could wish, and not more difficult to shoot with than a cylinder. But you must be just as quick with it—no poking and waiting, and frightening yourself with the idea that you are going to blow the game to pieces. At extremely short ranges any gun will make unpleasant holes in the victim. I tried the Dougall and choke carefully at 25 yards; the former put into a 30 in. circle 237 pellets, the latter 267; either gun at that range will put a large number of shot into a partridge, the choke perhaps three or four more than the cylinder—that is all the difference. At 40 yards the choke will always fetch down a partridge if the gun is held in the right place, whereas a cylinder will not do so. If any one wishes to convince himself that a miss at that range with an ordinary gun is not always the fault of the gunner, let him cut out, in thin oiled, and therefore transparent paper, the section of a partridge, with its wings extended (minus feathers, of course), and having made a diagram at 40 yards, lay the pattern on it—he will see the shot marks through the paper—move it about, and he will find a great many spaces, and near the centre too, where the bird would escape.

A partridge going straight away exposes a surface about the size of the top of a claret glass, plus the projection of the wing bones on either side of two inches by one-eighth. No gun but a good choke can make sure of so small an object at such a range.

In conclusion, when taking out the choke, let a man straightway forget what manner of gun it is, and shoot as usual; he is not likely to be disappointed.

Boughton House.

FRED. MORTON EDEN.

From THE FIELD, January 13th, 1877.

SIR,—I have recently been using a choke-bore, full choked, built for me by W. W. Greener, at rabbits ferreted in small coverts and hedge banks, and can therefore answer

some of the inquiries as to the effect of such guns for that kind of shooting. My gun weighs 7 lbs., is 28 in. long in the barrels, is light at the muzzle and heavy at the breech, and is an exceedingly handy one, with which I can get quickly on my quarry. I was desirous of finding a charge that, with No. 5 shot, would give a pattern of about 130 in a 30 in. circle at 40 yards, and found that with $3\frac{1}{2}$ drs. of No. 4 powder, a $\frac{3}{8}$ in. felt wad on powder, 1 oz. of No. 5 chilled shot, and card on shot, I could obtain a steady average of 130 pellets at such circles at 37 yards (the extent of my target range), the pellets being very evenly distributed over the whole circle, and with great force. This charge I have been using at rabbits with marvellous effect. It paralyses them so completely on hitting that they are utterly unable to move. The penetration is so good that the pellets pass clean through the rabbit when hit sideways, and when hit going straight away the penetration is proportionally deep, and they are rolled over at once. Not one that has been hit has escaped, and there has not been an instance of one being cut into ribbons, and afterwards creeping into a hole. The effect was the same at about 45 yards. An ordinary gun, with a charge of $1\frac{1}{8}$ oz. of No. 6 shot and $3\frac{1}{4}$ drs. of powder, puts into a similar circle from 130 to 140 pellets, but with far less penetration than the first-mentioned charge from the choke-bore, consequently the killing powers of the choke-bore are much greater. The rabbits that were shot at moderate distances were not spoilt, and those shot at very close quarters were not more so than would have been the case had they been shot with ordinary guns. If thicker shooting is required, the addition of $\frac{1}{8}$ oz. of similar shot, and also of a cloth or pink-edged wad on the powder gives a pattern of about 165. The addition of another $\frac{1}{8}$ oz. of shot, making $1\frac{1}{4}$ oz. of shot, the powder being kept up to $3\frac{1}{2}$ drs. throughout, brings the pattern up to about 180, and with great penetration, but without any appreciable recoil when using the gun at game. It is evident, therefore, that by the use of different sizes and charges of shot these guns can be

so loaded as to make them available for any description of shooting, and as I find that I can hit with this gun equally as well as with my other guns, I feel assured that choke-bores will become favourites in the hands of those who know how to use them, and who take care that the bend and length of stocks are right for them. Such guns will kill in a far cleaner manner, and score more game. Should thinner shooting be required, the shot only should be reduced, as reduction of the powder reduces the penetration, and tends to keep the shot more clustered, and makes the pattern less regular. Should less penetration be required, it is preferable to use smaller sizes of shot and lesser charges of them than to reduce the full charge of powder, as a full charge of the latter spreads the shot more, and makes the pattern far more even, thereby increasing the chances of hitting.

W. F. B.

SIR,—I have taken a very lively interest in all that has been written in *The Field* for the last twelve months as to your system of choke-bore guns. I say your system, because the whole merit is due to you as the first to bring it out and to demonstrate its superiority, and in doing so you have had to contend with a vast amount of prejudice. I think choke-bore is the very thing wanted for duck and wild-fowl shooting, and as an old sportsman I am free to confess I don't feel properly equipped, or at all happy, until I get one of your most approved make. If you will kindly give me a line informing me when you will be at your place of business in London, I would come up town for an interview.—Yours,
Colchester. J. C.

SIR,—I received the gun back safely, also your book on choke-bore guns, with which I am much pleased. It contains some very useful information, and is first-class as a

reference. Since my letter in *The Field*, two years since, where I said I had never killed single birds at 100 yards, I beg to state that since then I have done it, not only the herons I mentioned in my last, but ducks, oyster-catchers, and golden plover, have fallen to the hard hitting and close shooting of the 10-bore. The gun has not deteriorated in its shooting, as the left barrel still puts three-quarters of the charge in a 30-inch circle, at 40 yards. I quite agree with you, the chilled shot has much better penetration than the soft, and kills better.

C. METCALF.

Kingston Villa, New Parks, Scarborough.

[Second Letter.]

SIR,—When I was over at Scarborough a few weeks since I shot seven herons, four of which I killed at extraordinary distances with No. 4 shot. They were as follows : 80 yards, 95 yards, 110 yards, and 130 yards ; the last bird I fired at was at an angle of 50 degrees, and fell directly it was struck, falling head first, and as the day was fine and no wind, the distance I was off could not be over-estimated, as from where I stood to the dead bird it measured a trifle over 100 yards. I may mention that I fired at it out of spite, it having seen me and would not come nearer.

SIR,—I received the gun all safe, and must tender you my thanks for fulfilling my order to my entire satisfaction, both as to finish and shooting qualities of the gun ; and my friends to whom I have shown it claim that it is the prettiest gun they have yet seen.

G. W. P.

Mobile.

Extracts from THE FIELD.

SIR,—I have often read inquiries in your columns about choke-bore guns. I purchased a 12-bore last September direct from Greener, and must say that I have killed a few most extraordinary shots—viz., a wood pigeon (single bird) at least 100 yards distant; several partridges at or over 80 yards; one rabbit running, broadside on, distance measured 81 yards. I put five No. 6 shots into her, two of them passing clean through. Another most extraordinary shot:—I fired at a single mallard rising from the Thames, wounding the bird sufficiently for my companion to walk up to it and kill it afterwards. This distance was judged by three friends with me to be at least 150 yards. No. 4 shot used. I am prepared to prove all these statements, if required, by independent witnesses. I have since purchased a second gun for a friend, and that turns out equally good.

WILLIAM BOX.

Uffington, Faringdon, Berks, Jan. 12.

SIR,—Having purchased one of Greener's No. 12 choke-bores this season, I beg to give you the following as my experience of it. I consider it kills on an average at least 20 yards further than a non-choke bore, and if large shot is used will kill at great distances. I myself killed a heron sitting at 100 yards, and on skinning the bird found he was hit in five places. I have also tried it on wild-fowl with good success at distances at which an ordinary gun would not have been of any service. I have made good bags on snipe and other game during the last month without smashing the birds.

Leamington, Jan. 10.

You will be pleased to read the following :—I was out on the Monday following Christmas-day with a shooting-party in the bush, and had with me one of your noted PATENT TREBLE WEDGE-FAST guns that I purchased from you, when I did good work with it. I killed at 90 yards a fine bush buck ram, weighing about 150 lbs. ; hit him on the heart side ; had a charge of buck shot A.A.A. ; and a friend of mine killed a wild duck, with one I sold him, flying, at over 90 yards.

W. THOMPSON.

Port Elizabeth.

SIR, — I can only say that the 10-bore gun I got of you is the best I ever shot with, and I have tried some scores. I have read the late accounts in *The Field*, and am surprised that men do not try for themselves. I certainly, as you are aware, did not credit your first statement. I have tried the gun I think now under every circumstance, as regards different sizes of shot, and find it shoots all well and evenly, except during a gale of wind. My latest trial was with No. 1, $4\frac{1}{2}$ drams $1\frac{1}{2}$ oz. ; it put the whole charge into a 2ft. 10in. circle at 50 yards. The size of shot seems to make no difference as regards diameter of pattern. I have tried at hares with No. 4, and have killed them dead at 60 yards, going away, which is sufficient for me. I shot three golden plover, consecutive shots, at 65, 75, and 81 yards, dead. I have purposely tried it at gulls and ducks, which I consider pretty tough ; it is a certainty at 50 yards with No. 4. I have shot two out of three snipe with No. 6 at 50 yards. In fact I consider your gun 20 yards better than any gun I ever tried before.

J. D.

SIR,—The gun arrived safe, and I have spent a few days at plover shooting, and find that the gun shoots first class. I killed with one barrel at 45 yards twenty plover, I also killed a single plover at 63 yards, and two out of three that were flying at 80 yards. I killed three out of a flock of about 150 plover at 101 yards. The gun suits me in every way. I enclose you the account of the first pigeon match I shot with it ; you will see that I made the best shooting, killing my birds cleaner than any one.

W. M.

London, Ont.

[Second Letter.]

SIR,—The gun shoots better and better every day. I won the champion cup of London the other day at 26 yards rise ; killed seventeen out of twenty, and two out of bounds. Won it by four birds.

I shot in Toronto the other day against a 10-gauge gun at thirty-one birds, to see which gun killed the best. The 10-gauge killed twenty-six, I killed thirty ; the other fell dead out of bounds. I have shot nine matches and won every one with it. No money would induce me to part with it.

W. M.

London, Ont.

Extract from the American FIELD, January 9th, 1892.

Fulford made extra good kills on his thirteenth (a very strong driver from No. 3 trap), his fifty-fourth, and several others ; Fulford's first, twenty-first, fifty-seventh, and sixtieth

were birds that on a regulation boundary would have been lost birds.

The bounds for this match, although not quite what one man remarked, were all out of doors. I think in some directions the distance must have been over 100 yards.

Extract from Letter received February 15th, 1889.

In 1870 my father bought two 10-bore W. W. Greener guns, one of them has been in use continually ever since in the hands of my uncle in Dakota, and he writes me that the gun is as sound as when purchased nineteen years ago, the only breakage that ever occurred being the lever spring. He has killed upwards of 200 deer, and, to use his own expression, "over a steamboat load of wild fowl," with it. The gun has been re-stocked, and is apparently good for fifteen years to come. Your bolted extension rib, however, is incomparable, and I would purchase your gun for this feature alone.

H. M. D.

The Standard Work upon Firearms.

THE GUN AND ITS DEVELOPMENT.



With Notes on Shooting.

Fifth Edition.

Revised and Brought Down to Date,
with many Additions, containing
some 550 Illustrations, 750 Pages.

PRICE **10/6.**

“THE GUN AND ITS DEVELOPMENT” contains a full history of Early Firearms, and traces the evolution of the Modern Military Rifle and Sporting Shot Gun. No point of interest is left unnoticed, and the work has been thoroughly revised, added to, and brought down to date by varied additions.

A few Opinions of the Press.

“Written with creditable fairness.”—*The Times*.

“We can cordially recommend the book to our readers.”—*The Field*.

“An elaborate and comprehensive treatise.”—*Turf, Field, and Farm (New York)*.

“Artistic in character, and full of entertainment.”—*Illustrated London News*.

“A comprehensive encyclopædia. . . . An invaluable book of references, which will take its place unchallenged at the head of the literature of firearms.”—*Forest and Stream (New York)*.

“The handsome volume is a perfect storehouse of knowledge in reference to shooting and the implements of the shooter.”—*The Sportsman*.

“Most interesting and instructive.”—*United Service Magazine*.

The FIFTH EDITION now ready at all Bookstalls, or will be sent post free by the Author on receipt of price, **10/6.**

W. W. GREENER,

68, HAYMARKET, LONDON, S.W.; and

PRIZE WORKS, ST. MARY'S SQUARE, BIRMINGHAM.

Modern Shot Guns.

A Treatise on Modern Gunnery.



BY

W. W. GREENER.

Second Edition,

200 pp. and many Illustrations,

Price 5/-

THE BOOK FOR SPORTSMEN.

THE two hundred pages of this pocket encyclopædia of the Shot Gun contain the information which sportsmen seek, and which is indispensable to everyone who wishes to buy a gun to the best advantage, to keep it in perfect condition, or repair accidental breakages.

“MODERN SHOT GUNS” is a wonderfully comprehensive work, dealing with the Shot Gun in all its branches. It is divided into Three Parts—the First treating of the Gun historically, descriptively, analytically, technically, specifically, critically, and practically; the Second of Ammunition and Accessories; the Third Part of Trap Shooting. Of incalculable value to the Sportsman.

The book is profusely illustrated in the highest style of art, and altogether a work which no lover of the Gun should be without, it being both instructively and interestingly written.

May be had of the Publishers (CASSELL & COMPANY), of all Booksellers, or of

W. W. GREENER,

**68, HAYMARKET, LONDON, S.W.; and
ST. MARY'S SQUARE, BIRMINGHAM.**

The Latest Great Win to the Greener Gun.

“ Kansas City, Mo.,
“ August 2, 1892.

“ W. W. GREENER, Esq.,
“ St. Mary’s Square, Birmingham, England.

“ My Dear Sir,—I enclose herewith several newspaper clippings giving a correct account of my record in recent contests for the American Field Championship Cup, as well as the local championship trophy. The latter shoot took place on Thursday, the 28th ult., it being necessary for me to score 35 straight kills in order to win.

“ In the contest with Mr. James A. Bolen for the American Field Cup my score was 49 out of 50. In the ten shoots for this trophy at 500 birds I have killed 479, or an average of 47.9 out of 50. These scores, I think you will agree, have never been equalled in this country. **In all of the events I have used the GREENER GUN.**

“ Yours truly,
“ J. A. R. ELLIOTT.”

Scores made for the American Field Champion Wing-Shot Cup:—

1.	J. A. R. ELLIOTT ...	47		GEORGE C. BECK ...	43
2.	J. A. R. ELLIOTT ...	47		SAM GRAY, Jun. ...	45
3.	J. A. R. ELLIOTT ...	48		JAMES E. HAGGERTY ...	47
4.	J. A. R. ELLIOTT ...	48		W. B. CROSBY ...	39
5.	J. A. R. ELLIOTT ...	48		JAMES E. HAGGERTY ...	45
6.	J. A. R. ELLIOTT ...	49		C. W. BUDD ...	46
7.	J. A. R. ELLIOTT ...	50		W. B. CROSBY ...	48
8.	J. A. R. ELLIOTT ...	47		A. W. WILEY ...	43
9.	J. A. R. ELLIOTT ...	46		E. D. FULFORD ...	43
10.	J. A. R. ELLIOTT ...	49		JAMES A. BOLEN ...	40

The Cup has now become the property of Mr. ELLIOTT, he having successfully held it for two years against all comers winning it ten times in succession.

Prices of
W. W. GREENER'S
BREECH-LOADING GUNS,
 WITH ALL THE LATEST IMPROVEMENTS.

HAMMER GUNS.

No. 203.	A Top-lever Gun, with either Bar or Back action, Laminated or "Siemens" Steel Barrels ...	£10 10 0
No. 108.	Greener's " <i>Forester</i> " Gun, Treble-wedge-fast Cross-bolt, Rebounding locks, Front action, Engine-turned rib, neatly finished, and slightly engraved	13 13 0
No. 107.	Greener's "Far-killer"	16 16 0
No. 106.	Superior make and finish Better qualities, 25, 30, 35, 40, and 45 guineas.	21 0 0
No. 100.	Royal Quality	57 15 0

SINGLE BARRELLED GUNS

From 5 to 10 guineas.

HAMMER DUCK GUNS.

Single Barrel	8-bore Duck Guns from 15 guineas.	
,,	,, 4-bore ,, ,, ,, 20 ,,	
Double	,, 8-bore ,, ,, ,, 20 ,,	
,,	,, 4-bore ,, ,, ,, 30 ,,	

HAMMERLESS DUCK GUNS.

Single Barrel 8-bores from 25 guineas.

,,	,, 4-bores ,, 30 ,,	
Double	,, 8-bores ,, 30 ,,	
,,	,, 4-bores ,, 40 ,,	

GREENER'S HAMMERLESS GUNS.

The "Facile Princeps" lock mechanism, the celebrated Treble-wedge-fast Breech Mechanism, patent side Safety Bolt, with which these guns are fitted, have given every satisfaction in all parts of the world.

- No. 28. A plainly-finished, well-made, Hammerless Gun
without engraving £16 16 0
- No. 27. Better quality, neatly finished and engraved 21 0 0
- No. 26. With Greener's "Sterling Steel" or English Laminated Steel Barrels 26 5 0
- This Type of Gun, 12-bore, can be made, with 27-inch barrels,
as light as $5\frac{3}{4}$ lbs.
Better qualities, 30, 35, 40, and 45 guineas.
Royal Quality, £57 15s.
-

W. W. GREENER'S SELF-ACTING EJECTOR GUNS.

- No. 5. The highest development of the Sporting Shot Gun,
neatly engraved, and well finished £36 15 0
Better qualities, 40, 45, and 50 guineas.
- No. 1. Royal Quality, being the very best, both as to
material and workmanship; the Barrels,
Greener's "Sterling Steel," best Laminated
Steel, or finest English Damascus; and the Gun
most tastefully finished and artistically engraved
with sporting scenes or fine scroll design 63 0 0
-

Repairs should be sent direct to the factory at Birmingham, when a quotation (net and for cash) will be given.

W. W. GREENER'S RIFLES.

- Double Express Rifles with hammers .400, .450,
or .500-bore from £17 17 0
.577-bore 2 guineas extra on all grades.
- Hammerless Express Rifles from 30 to 60 guineas.
- Elephant Rifles, 4 and 8-bore, from 40 guineas.

GREENER'S MARTINI SINGLE EXPRESS AND LONG-RANGE RIFLES.

Prices for Express Rifles '360, '400, '450, '500-bore, fitted with Martini action, from 6 to 10 guineas.

'577 Express, 8 to 10 guineas.

Rook Rifles with Martini action, 4, 5, and 6 guineas, with top lever and side lock, superior quality, 8 to 10 guineas.

Volunteer, Match, and other Long-Range Rifles, 5, 6, and 7 guineas.

All kinds of Volunteer Requisites and Shooting Accessories supplied.

The New Regulation '303 Magazine Rifle, identical with those in use by her Majesty's forces, 10 and 12 guineas.

'303, fitted with the Martini action, 8 and 10 guineas.

REVOLVERS.

Greener's Bull - Dog Revolver, '320, '360, '380, and
'450-bores each £2 2 0

Cheaper qualities, 30s., 21s., and 12s. 6d.

Very superior self-acting Army Revolver, same as supplied to
the British Government £6 6 0

CARTRIDGES FOR SHOT GUNS.

All W. W. Greener's Cartridges are loaded in one way with perfected machinery, whilst the pellets of the charge are *counted* in. The same exactitude is observed in choosing and fitting the wadding, etc. The prices are the lowest possible for the best quality cases and material, and careful loading.

PRICES OF LOADED CARTRIDGES.

The "Smokeless Cartridges," 12-bore, per 100.

"*Sporting Life*" Cases, "Schultze," "E.C.," or "S.S.," 42 grs. and $1\frac{1}{8}$ oz., 10s. 6d. cash, or 11s. 6d. booked.

Or in red or buff Cases, "Schultze," "E.C.," or "S.S.," 45 or 47 grs., and $1\frac{1}{8}$ oz., 11s. cash, or 12s. booked.

Ditto, 47 grs. and $1\frac{1}{4}$ oz., 11s. 6d. cash, or 12s. 6d. booked.

The "Prize" Cartridges, 12-bore, per 100.

Green or blue paper Cases, 3 drams and $1\frac{1}{8}$ oz., 9s. 6d. cash, or 10s. 6d. booked.

$3\frac{1}{4}$ drams and $1\frac{1}{8}$ oz., 10s. cash, or 11s. booked.

$3\frac{1}{4}$ drams and $1\frac{1}{4}$ oz., 11s. cash, or 12s. booked.

"Perfect," "Perfectly Gas-tight," "Grouse," or other fancy Cartridge Cases, 6d. per 100 more; $2\frac{1}{4}$ -in. Cases, 6d., and 3-in. Cases, 1s. per 100 extra.

The "London Club" Cartridge.—In Eley's Green Cases, with special large Caps, for best Black Powder and Soft Shot, at 9s per 100 for 12-gauge. For "Schultze" or "E.C." powders, in Eley's Special Cases, at 10s. per 100 for 12-gauge.

W. W. Greener's "Gamekeeper's" Cartridges.—Loaded in Eley's Brown Cases, with superior Black Powder, four wads, and Walker Parker shot, accurately loaded and thoroughly reliable, 6s. 9d. per 100.

Small Bores.—From the above prices deduct 6d. per 100 for 16-bores and 1s. per 100 for 20-bores, with usual charges; other sizes and loads at special prices.

The above prices are for delivery at 68, Haymarket, London, S.W., or at the Works, St. Mary's Square, Birmingham. No Railway Carriage or PACKING CASES are included in these prices.

Strong Packing Boxes, to hold 100, 200, 300, 400, 500, or 1,000 Cartridges, 3d., 6d., 9d., 1s., 1s. 3d., or 2s. 6d.

Delivery, Carriage forward or paid, to any Railway Station at home or abroad, by arrangement.

Empty Cartridge Cases.—Ordinary Best quality, Blue, Red, Green, and “*Sporting Life*” Cases, or Eley’s, Joyce’s, or Kynoch’s, at 40s. per 1,000. Fancy Paper Cases and “*Perfects*” from 42s. 6d. per 1,000. “*E. B.*” Brown Cases, 30s. per 1,000. 20-bores, 1s. per 1,000 less.

Gunpowder, Shot, and Wadding.—Very best Black Gunpowder, No. 4 Alliance, retail at 2s. per lb.; “*Gamekeepers*” Powder, 1s. 6d. per lb.; GENUINE NEWCASTLE CHILLED SHOT, 8s. per 28 lbs. “*SCHULTZE*,” “*E.C.*,” and “*S.S.*” at 8s. per lb. Felt Wadding, 3s. to 5s. per lb.; Pink-edged ditto, 5s. per 1,000. Waterproof and Card ditto, 1s. and 1s. 6d. per 1,000.

TERMS.—*On no account will the Cash with Order Prices be allowed unless the Cash accompanies the order; otherwise the Quarterly Booked Prices will be charged.*

INANIMATE TARGETS FOR MATCHES AND PRACTICE.

The “*Blue Rock*” Target is the best imitation of the living bird.

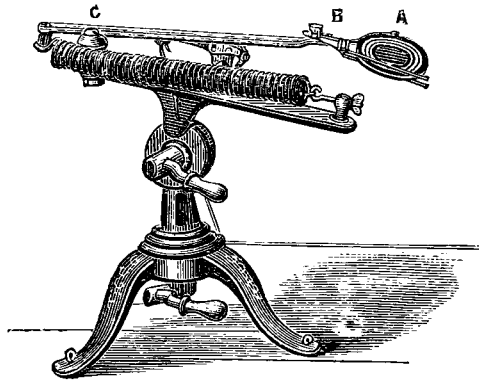

THE “*BLUE ROCK*” TARGET TRAP.

	<i>Net Cash Only.</i>
The Standard “ <i>Blue Rock</i> ” or other First-quality Trap ...	£2 2 0
„ “ <i>Blue Rock</i> ” or other First-quality Targets per 100 ...	0 8 4
„ Cord for Trap	0 1 0

No allowance made for breakages in transport.

These Traps and Birds are obtainable only of W. W. GREENER, at any of his addresses.

W. W. GREENER'S GLASS-BALL TRAPS.

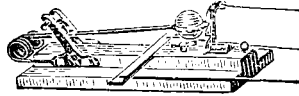

THE "CARVER."

Fixed or Stationary Trap. Very strong and easily adjusted.

Price for single ball	£1	1	0
To throw two balls	<i>extra</i>	0	5	0

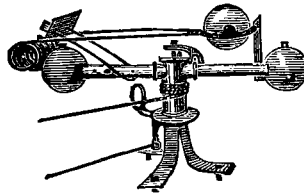

THE ROTATING TRAP.

Throws the ball any direction but towards the shooter. Can be used as a Stationary Trap if desired.

Price for single	£2	2	0
If to throw two balls	2	7	0

Pigeon Traps, best quality, as used at the Gun Club, £2 2s. each.



W. W. GREENER,
ARMS MANUFACTURER,

Contractor to the British and Foreign Governments.

AIR CANES
AND
WALKING-STICK GUNS.

Bent Air Canes,

With Rifle and Shot Barrels, to use from the
Shoulder. Complete with Pump and Key,

Price **55s., 60s., 80s., and 98s.**

If Breechloading, **8s.** extra.



The
**Improved Central-
fire Walking-Stick
Gun,**

For the 410 Cartridge,
with Movable Butt
and Safety Bolt.

Price **50s.**

W. W. GREENER,

68, Haymarket, London, S.W.

Works—*St. Mary's Square, Birmingham.*

THE  COMPANY'S
 "SMOKELESS SPORTING POWDERS."

TRADE

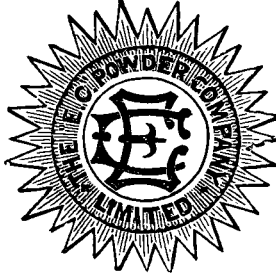

MARK.

TWO SILVER MEDALS.

Highest Award for Gunpowder.

PIGEON SHOOTING AT THE GUN CLUB, &c., 1891 AND 1892.

A RECORD FOR "E.C." POWDER.

Three Members' Challenge Cups won outright within a year with "E.C." POWDER in both barrels, clearly demonstrating the regularity and penetration of this well-known Powder.

WINTER SHOOTING, 1891-2.

Forty Prizes were won with "E.C." POWDER in both barrels, as against *seven* only with any other powder alone.

SUMMER SEASON, 1892.

At HURLINGHAM and the GUN CLUB 114 winners used "E.C." POWDER in both barrels, the highest number of winners using any other powder alone being sixty-seven.

**INTERNATIONAL WEEKS.—LONDON, 1889, 1890, 1891,
AND 1892.**

The highest percentages of kills by the use of any one powder alone were obtained by gentlemen using "E.C." POWDER in both barrels. During the INTERNATIONAL WEEK, 1891, prizes were won with "E.C." POWDER alone amounting to nearly three times the value of those won with all other powders combined.

The 33 and 32 Yards Sweepstakes, the longest distance sweepstakes shot for at the Gun Club in 1890 and 1891, and the Champion Stakes, 1892, were all won by gentlemen using "E.C." POWDER in both barrels.

N.B.—The "E.C." POWDER, as at present manufactured, is by far the MOST RELIABLE SMOKELESS POWDER, being hard in grain, free from dust, and regular in combustion. Pattern and penetration better and more regular than those of any other sporting Powder.

The public are cautioned against inferior and cheap imitations.

SOLD WHOLESALE BY

PIGOU, WILKS, & LAURENCE, LIMITED,
11, Queen Victoria Street, London, E.C.

Sole Mercantile Agents for Great Britain and the Colonies.

T *

THE NEWCASTLE CHILLED SHOT COMPANY, LIMITED.

SOLE MAKERS OF NEWCASTLE

“CHILLED SHOT.”

Beware of Imitations.



Special attention is called to the Trade Mark, as imitations of the Company's manufacture are being offered and sold as Chilled Shot.

NEWCASTLE CHILLED SHOT has no equal for hardness, rotundity, uniformity in shape, and evenness in size.

This Shot is now being used by all the leading English and Continental Pigeon Shooters. It gives greater penetration, superior pattern at long ranges, and keeps its shape better than any other kind of Shot. See records of the London Gun Trials of 1875, 1877, 1878, 1879, as to its superiority.

Manufactured by improved machinery, it is without equal for use in Choke-bores or Cylinders, and has no deleterious effect upon the Gun Barrels.

The Company are the SOLE MANUFACTURERS of CHILLED SHOT, which is composed of lead only, and free from any poison.

Offices and Works :

GATESHEAD-ON-TYNE, ENGLAND.

PERFECTED AMMUNITION

FOR THE

MODERN BREECH-LOADER,

MANUFACTURED BY

KYNOCH, BIRMINGHAM.

Thoroughly Damp-proof and Gas-tight.

Turns down like a Paper Case.

Ejects Easily.

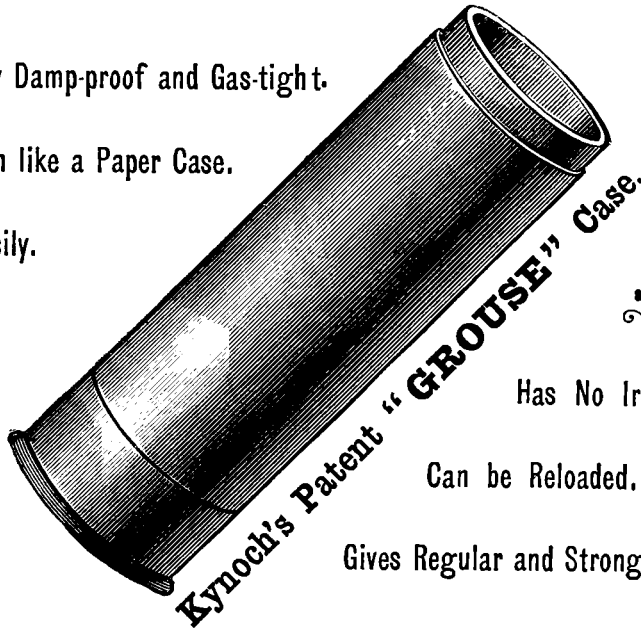

Has No Iron Lining.

Can be Reloaded.

Gives Regular and Strong Shooting.

Kynoch's Patent "Perfectly Gas-Tight" Case.

Construction similar to that of the "GROUSE," but the solid-drawn tube under the head is shorter, leaving more paper exposed.

Blue and Brown Cases of Unequalled Quality.

LOADING A SPECIALITY.

Express, Rook Rifle, and Revolver Cartridges.

G. KYNOCH & COMPANY, LTD.

WITTON, BIRMINGHAM.

S. ALLCOCK & Co.,

STANDARD WORKS, REDDITCH.

MANUFACTURERS OF
FISH HOOKS, FISHING RODS, LINES,
REELS, and FISHING TACKLE
of every description.

*HIGHEST AWARDS at Fifteen
International Exhibitions.*

(WHOLESALE ONLY.)

BRANCH HOUSES: Toronto, Canada.

GUT FACTORY: Murcia, Spain.

LONDON OFFICE: 60, Queen Victoria Street.

PARIS: E. Foucault, 77, Rue Rambuteau.

VIENNA: Otto Noot, III. Heumarkt.

NEW YORK: The U.S. Net and Twine Company,
219, Fulton Street.

MELBOURNE REPRESENTATIVE: Mr. J. D.
WRAGG, Olderfleet Chambers, Collins Street.

SCHULTZE GUNPOWDER

(SMOKELESS).

IMPROVED WATERPROOFED.

MANUFACTURED AT THE WORKS OF

The SCHULTZE GUNPOWDER COMPANY,
LIMITED,
EYEWORTH LODGE, HAMPSHIRE.

TRADE

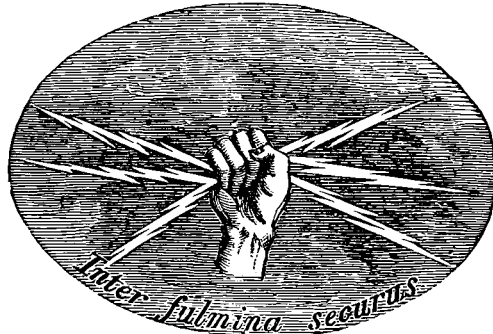

MARK.

PIGEON SHOOTING.

All the principal events of late years:

The GRAND PRIX DU CASINO, Monte Carlo, 1886, 1887, 1888, 1889, 1891, 1892
The TRIENNIAL CHAMPIONSHIP, Monte Carlo, 1889 and 1892.
The HURLINGHAM CUP, 1886, 1887, 1888, 1889, 1890, 1891.
The GUN CLUB INTERNATIONAL CUP, 1886, 1887, 1888, 1889, 1892.
The GUN CLUB CHALLENGE CUP, 1892, 11 out of 13 competitions.

AGENTS:

United States.—VON LENGERKE & DETMOLD, 8, Murray Street, New York.
Canada.—H. S. HOWLAND, SONS & Co., Toronto.
India.—MANTON & Co., 13, Old Court House Street, Calcutta.
TREACHER & Co., LIMITED, Bombay.
OAKES & Co., Exchange Hall, Madras.

Italy.—LUIGI COLOMBO, 23, Piazza Nuova, Genoa.
New South Wales.—MCLEAN BROS. & RIGG, LIMITED, Sydney.
Victoria.—H. ABRAHAMS & Co., Elizabeth Street, Melbourne.
Ireland.—CAMBRIDGE & Co., Carrickfergus.

To be had Retail and in Cartridges from all respectable Dealers, and by Traders Wholesale at the Offices of

The SCHULTZE GUNPOWDER COMPANY, Ltd.,
32, GRESHAM STREET, LONDON, E.C.

CAUTION.—“Schultze” is the oldest, best known, and most reliable Smokeless Powder, and the Public is cautioned against inferior and imitation powders.

ELEY'S Breechloading Cartridges.

*Cartridge Cases and Cartridges must be kept
in a Dry place.*

*As Cartridge Cases of an inferior make are frequently sold
as ours, please note that all Cases manufactured by us have
"ELEY" printed on either the Metal Base or Paper Tubes, and
our Labels on the Packages.*

A M M U N I T I O N

FOR

Sporting, Express, and Military Rifles

OF ALL KINDS, AND ALSO FOR

EVERY DESCRIPTION OF REVOLVER.

To be had of all Gun Makers.

ELEY BROTHERS, LIMITED,
LONDON, BIRMINGHAM, & LIÉGE.

WHOLESALE ONLY.

PIGOU, WILKS, & LAURENCE, *LIMITED.*

Head Office - 11, Queen Victoria Street, London, E.C.

Mills - - Dartford, Kent.

CONTRACTORS TO

H.M. Navy and War Office, the Colonial
and principal Foreign Governments.



Manufacturers of Every Description of

**MILITARY, SPORTING, AND
MINING POWDERS.**



SOLE MAKERS OF

The "Alliance" Prize Sporting Powder,

which, at the last "Field" Trials, conducted under the management of the Editor of "The Field," attained the *Highest Average Figure of Merit* in competition with all other leading brands of Sporting Powder.

“Forest and Stream.”

*The Leading American Journal of Shooting,
Fishing, Yachting, Canoeing, Camp
Life, and Travel.*

YOU may go fishing and catch no fish, or shooting and get no game, but you cannot buy a copy of “FOREST AND STREAM” without finding it brimful of capital sketches of shooting and fishing, and papers on natural history and sportsman’s travel and experiences, and discussions of yachting and canoeing.

Established in 1873, the “FOREST AND STREAM” has exerted an important influence in the development of outdoor sports in the United States. The popularity of these sports has increased at a marvellous rate during the last decade, and promises to attain greater proportions in the immediate future. With this development the “FOREST AND STREAM” has kept equal pace in worth, influence, and circulation. It is to-day, as in the past, recognised as the representative exponent of the American sportsman’s interest.

Every number is handsomely illustrated with sketches of camp life, fish and game, yacht and canoe races, and portraits of dogs.

Send for particulars of the “Forest and Stream” Amateur Photography Competition, open to the world.

“FOREST AND STREAM” PUBLISHING CO.,
318, Broadway, New York, U.S.A.

Books on American Sport and Travel.

We publish an extensive list of the Best Works on American Fish and Game, Sport, Field, Adventure, and Travel. Among others are:

SAMUELS—With Fly-Rod and Camera\$5 00
NESSMUK—Woodcraft 1 00
SENECA—611 Hints and Points for Sportsmen ...	1 50
WEEKS—Log Cabins: How to Build and Furnish Them ...	1 50
BOGARDUS—Field, Cover, and Trap Shooting	2 00
HAMMOND—Practical Dog Training; or, Training vs. Breaking	1 00
MERCER—The Spaniel and its Training	1 00
STEPHENS—Canoe and Boat Building for Amateurs ...	2 00
KUNHARDT—Small Yachts: Their Design and Construction...	10 00

We also supply every Book published in these fields; among them—

Greener's

“Modern Shot Guns”

AND

“The Gun and its Development.”

Send for our FREE ILLUSTRATED CATALOGUE.

FOREST AND STREAM PUBLISHING COMPANY,
318, Broadway, New York.

LONDON AGENTS; DAVIES & CO.,
No. 1, Finch Lane, Cornhill.

F. GREENER & Co., Edmund Street, Birmingham.



THE "GREENER" LIGHT ROADSTER.

(Weight, with $1\frac{3}{4}$ inch Pneumatics, about 36 lbs.)

PRICE ... **£18 : 0 : 0** nett, Cushion Tyres.
£20 : 0 : 0 nett, Pneumatic Tyres.

THE "GREENER" MODEL A.

PRICE ... **£17 : 0 : 0** nett, Cushion Tyres.

THE "GREENER" MODEL B.

PRICE ... **£14 : 0 : 0** nett, Cushion Tyres.

THE "GREENER" MODEL C.

PRICE ... **£10 : 10 : 0** nett, Cushion Tyres.

Pneumatic Tyres fitted to the above, price £2 extra, nett.

THE "GREENER" CYCLES.

F. GREENER & CO.,
EDMUND STREET, BIRMINGHAM, ENGLAND.

THE BREECH-LOADER

AND HOW TO USE IT

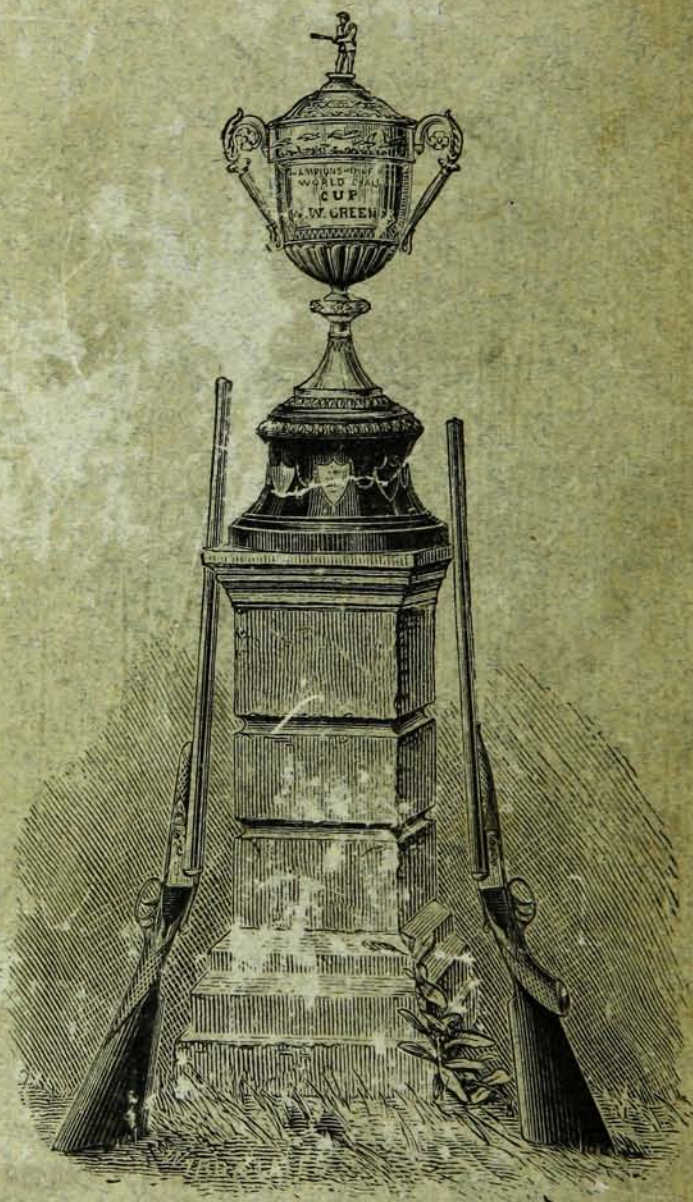

W. W. GREENER